

Warehousing and storage

A guide to health and safety



This is a free-to-download, web-friendly version of HSG76 (Second edition, published 2007). This version has been adapted for online use from HSE's current printed version.

You can buy the book at www.hsebooks.co.uk and most good bookshops.

ISBN 978 0 7176 6225 8

Price £14.50

This book is for managers, supervisors and those with other health and safety interests in warehouses and storage facilities. It will also be useful to employees and health and safety representatives.

The Health and Safety Executive (HSE) has written this guide in liaison with the Warehousing Health and Safety Forum, a joint committee representing trade associations, trade unions and employer organisations.

The guide is intended as an aid to health and safety management, to help reduce injuries and occupational ill health, and help the industry achieve the government's injury reduction and occupational ill health targets for UK workplaces.

Although most of the book will apply to the processes in a range of premises, some warehouses may find parts less relevant to their business (eg temperature-controlled storage), and some specialist warehouses may need more information (eg on storage of dangerous substances). However, most chapters will be of interest to warehouses and storage facilities of all sizes.

It covers topics that require special attention, including manual handling and musculoskeletal disorders; slips and trips; workplace transport; and falls from height. It also contains guidance on other hazards found in warehouses, such as storage systems, mechanical handling and electrical safety. It also provides information on the working environment and how to deal with accidents and emergencies.

© *Crown copyright 2007*

First published 1992
Second edition 2007

ISBN 978 0 7176 6225 8

All rights reserved. No part of this publication may be reproduced, stored in a retrieval system, or transmitted in any form or by any means (electronic, mechanical, photocopying, recording or otherwise) without the prior written permission of the copyright owner.

Applications for reproduction should be made in writing to:
The Office of Public Sector Information, Information Policy Team,
Kew, Richmond, Surrey TW9 4DU or e-mail: licensing@opsi.gov.uk

This guidance is issued by the Health and Safety Executive. Following the guidance is not compulsory and you are free to take other action. But if you do follow the guidance you will normally be doing enough to comply with the law. Health and safety inspectors seek to secure compliance with the law and may refer to this guidance as illustrating good practice.

Contents

Introduction 4

General health, safety and welfare 5

Health and safety management 5

Managing the workforce 8

Occupational health 12

Environment and welfare 24

Slips and trips 35

Electrical safety 42

Accidents and emergencies 48

Materials handling 53

Manual handling 53

Mechanical handling 60

Vehicles in and around the warehouse 79

Work at height 93

Storage 101

Storage systems 101

Automated storage and retrieval systems 118

Temperature-controlled storage 125

Storage of packaged dangerous substances 135

Appendix 1 Warehousing Health and Safety Forum membership 144

Appendix 2 Transport hazard diamonds 145

Appendix 3 Common types of truck 146

References 147

Further reading 150

Further information 155

Introduction

1 This guidance is the second edition of a book that was first published in 1992. It is for people who have management, supervisory or other health and safety interests in warehouses and storage facilities. It will also be of value to employees and their health and safety representatives.

2 It is intended as an aid to health and safety management, to help reduce the numbers of injuries and cases of occupational ill health.

3 Although most of the information in this book will apply to processes in a range of premises, some warehouses may find parts less relevant to their business (eg temperature-controlled storage), whereas specialist warehouses may find they will require additional sources of information (eg on storage of dangerous substances). However, most of the chapters will be relevant to warehouses and storage facilities of all sizes. References, further reading and useful websites are listed at the back of this book.

4 The Health and Safety Executive (HSE) has written this second edition in liaison with the Warehousing Health and Safety Forum. The Forum is a joint committee with representation from trade associations, trade unions and employer organisations.

The challenge

5 The Warehousing Health and Safety Forum and HSE encourage all those who manage or work in warehouses to work towards the government's injury reduction and occupational ill health targets for UK workplaces.

6 If you run a warehouse you can reduce your health and safety risks, and your costs, by concentrating health and safety efforts on the main causes of injury and occupational ill health at your premises. Once you have identified the main causes, which will probably be listed in this book, this guidance will help you to identify what action you need to take to reduce injuries and ill health.

7 Success is more readily achieved with full involvement of the workforce and trade union/employee safety representatives when identifying both the problems and the practical solutions.

The priorities

8 The Forum and HSE have identified certain priority topics requiring attention within the storage and warehousing industry. They are all covered in this book and include:

- manual handling/musculoskeletal disorders;
- slips and trips;
- vehicles in and around the warehouse; and
- work at height.

9 This book also contains useful guidance on other hazards found in warehouses, such as storage systems, mechanical handling and electrical safety. It also provides information on the working environment and how to deal with accidents and emergencies.

The meaning of ‘reasonably practicable’

10 Throughout this book there are some references to doing what is ‘reasonably practicable’ to comply with the law.

11 This means that you have to take action to control the health and safety risks in your workplace except where the cost (in terms of time and effort as well as money) of doing so is ‘grossly disproportionate’ to the reduction in the risk. You can work this out for yourself, or you can simply apply accepted good practice.

General health, safety and welfare

Health and safety management

12 Warehousing and storage cover a wide range of activities that can result in various hazards and risks. Effective health and safety management involves you, the employer, looking at the risks that arise in the workplace and then putting sensible health and safety measures in place to control them. By doing this you can protect your most valuable asset, your employees, as well as members of the public from harm. You will also help protect your premises, goods, equipment and reputation.

13 Accidents, injuries and ill health are reported to the health and safety enforcing authorities under the Reporting of Injuries, Diseases and Dangerous Occurrences Regulations 1995 (RIDDOR). Paragraphs 332–337 give more information on RIDDOR reporting requirements.

The main cause of injuries in warehousing

Major injuries

14 Around a quarter of major injuries (broken bones, injuries requiring hospitalisation for more than 24 hours etc) in the warehousing industry are caused by workers slipping or tripping. In the past, a slip or trip accident may not have been viewed as seriously as an accident involving a fork-lift truck. However, it is clear from the pattern of major injuries that workers who slip or trip are sustaining serious injuries from the fall or from impact with objects or structures.

15 Manual handling, being hit by moving or falling objects and falls from height also cause a significant number of major injuries. See Figure 1.

Over-3-day absence

16 The manual handling of loads is the main cause of reported over-3-day injuries. As well as being the prime cause of major injuries, slips and trips are also a significant cause of over-3-day injuries. See Figure 2.

Figure 1 Causes of major injuries in storage and warehousing (2005/06)

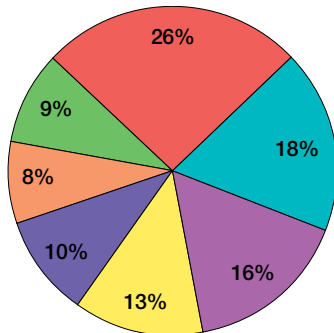
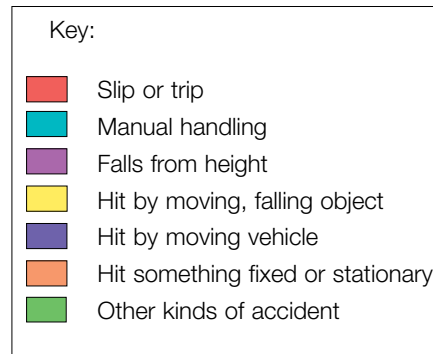

Figure 2 Causes of over-3-day absence injuries in storage and warehousing (2005/06)



Health and safety policy

17 A health and safety policy statement is a starting point to managing health and safety in the workplace. It sets out how health and safety will be managed in your organisation – it shows who does what, and when and how they do it. If you have five or more employees, you will need to have a written health and safety policy statement.

Managing health and safety

18 Warehousing is a complex industry that can expose workers to a multitude of risks; health and safety should be proactively managed just like any other part of the business.

19 The Management of Health and Safety at Work Regulations 1999¹ require employers to put in place appropriate health and safety arrangements. This means having an effective health and safety management system. The complexity of this system should reflect the organisation's activities.

20 Steps to successful health and safety management include:

- identifying the key health and safety priorities within a business;
- concentrating efforts on these priorities;
- assessing the risks to employees and others;
- eliminating risks where possible. Where risks can't be eliminated, they should be reduced to an acceptable level;
- using safe systems of work;
- providing the workforce with adequate information and training;
- involving the workforce and health and safety representatives in decision making on health and safety issues; and
- regularly reviewing performance.

21 *Successful health and safety management* HSG65² gives more information on health and safety management systems.

Risk assessment

22 The first step in managing health and safety is to identify the priorities – ie to carry out a risk assessment. This book will help as it covers the recognised main hazards in warehouses. It is also important to consider additional hazards specific to a site that may also need attention.

23 Risk assessment is an important step in protecting your workers and your business, as well as complying with the law. It helps you focus on the risks that really matter – the ones with the potential to cause real harm. You are legally required to assess the risk in your workplace so that you can put in place a plan to control them.

24 A risk assessment is simply a careful examination of what in your work could cause harm to people, so that you can weigh up whether you have taken enough precautions or should do more to prevent harm. Workers and others have a right to be protected from harm caused by a failure to take reasonable control measures.

25 The law does not expect you to eliminate all risk, but you are required to protect people 'so far as is reasonably practicable'.

26 When thinking about your risk assessment, remember:

- a hazard is anything that may cause harm, such as chemicals, electricity, working from ladders, an open drawer etc;
- the risk is the chance, high or low, that somebody could be harmed by these and other hazards, together with an indication of how serious the harm could be.

27 Risk assessment can be broken down into five steps:³

Step 1 identify the hazards;

Step 2 decide who might be harmed and how;

Step 3 evaluate the risks and decide on precautions;

Step 4 record your findings and implement them; and

Step 5 review your risk assessment and update if necessary.

28 If you employ five or more people you must keep a record of the significant findings of your assessment. The record should be fit for purpose – paperwork is a means to an end rather than an end in itself. Examples of risk assessments are published on the risk pages of HSE's website; these help you identify what is expected in practice.

29 Many risks in a warehouse may already be well controlled, eg the correct industrial trucks may be used and the drivers correctly trained, but you should also consider other issues such as supervision, monitoring and maintenance.

30 Workers should be actively involved in the risk assessment process.

Investigating accidents and incidents

31 Investigating any accidents that occur will help you identify further actions that you need to take. The outcome of an investigation can also help with a review of risk assessments.

32 Sometimes it is obvious what action needs to be taken. Sometimes accidents/incidents can be complex and need to be more thoroughly investigated, eg by looking at systems of work. The procedure in Checklist 1 can be used to investigate accidents and incidents.

33 *Investigating accidents and incidents: A workbook for employers, unions, safety representatives and safety professionals* HSG245⁴ gives more information on accident investigation.

Checklist 1: **Investigating accidents and incidents**

Check what happened:

- find out about the circumstances leading up to the accident/incident;
- identify the hazards that contributed to the accident/incident, eg:
 - plant, equipment, tools or substances in use;
 - work environment (such as floor surface, lighting, temperature);
 - the way the work is organised (who is doing what and when); and
 - training and skills of those involved.

Prevent the accident/incident happening again:

- identify what has already been done to minimise the risk;
- decide on additional precautions required to prevent similar accidents/incidents;
- ensure the additional precautions are implemented; and
- review the new precautions to ensure they remain effective.

Keep records of any investigations you carry out.

Managing the workforce

34 The workforce is a valuable asset and your workers are directly involved in the day-to-day running of your business. Effective management of the workforce is vital to good health and safety management.

Selecting workers

35 Before selecting someone for a job, you should identify if the job has any special demands. You should then ensure that the person applying for the job can meet these demands. Also consider what arrangements can be put in place to accommodate a worker's requirements.

Training

36 All employees should have basic training in health and safety. All warehouse workers should have adequate training in the hazards associated with their work and within the warehouse, along with the precautions to take. For example, all operators of work equipment, including vehicles, should be suitably trained in the hazards of the equipment they use and the precautions that apply as well as safe operation.

37 Managers and supervisors also require suitable training and should be competent for their role.

38 Consider any specific legal requirements for job training, eg requirements for first-aiders (see paragraphs 323–331) or for fork-lift truck drivers (see paragraphs 444–452).

39 You can obtain information and advice on training from:

- the supplier of the material, substance or equipment;
- training centres or colleges of further education;
- trade associations;
- trade unions;
- HSE;
- local authority environmental health departments;
- professional bodies (eg the Institution of Occupational Safety and Health);
- voluntary bodies (eg the Royal Society for the Prevention of Accidents, the British Safety Council);
- skills councils such as Skills for Logistics.

Refresher training

40 Employee competence can decline if skills are not used regularly (eg emergency procedures or where an employee deputises for another). Training therefore needs to be repeated periodically to ensure continued competence.

Checklist 2: Training programme

Consider the following when preparing a typical training programme:

Organisation

- Will training be 'on' or 'off' the job?
- Who will do the training? (Will they be competent?)
- Who will supervise the training? (Will they be competent?)
- How will the trainees' competence be assessed?
- What will the trainee be competent in at the end of the training?
- What records will be kept?
- Who will keep the records?

Basic instruction

For each task, prepare a list of all the points training should cover, eg:

- the method of work;
- the equipment or substance used;
- how the equipment or substance works and what it does;
- any dangers that are associated with its use, including accidental spillage;
- any safety precautions needed, and how they protect the user;
- how to clean equipment safely;
- what to do if equipment seems faulty; and
- what personal protective equipment to wear.

Supervised working

- Make sure the supervisor is competent for the training task.
- Set the trainee to work under close supervision.
- Ensure the supervisor has the time and knowledge to supervise effectively.
- Ensure the supervisor watches closely to see that dangerous practices do not develop.

Specific groups of workers

Young people

41 In addition to an employer's general duty to assess the health and safety risks, there are particular responsibilities towards young people. These are:

- to assess risk to all young people under 18 years of age, before they start work;
- to ensure the risk assessment takes into account inexperience, and lack of awareness of existing or potential risks;
- to introduce control measures to eliminate or minimise the risk, so far as is reasonably practicable.

42 There are specific risks that you have to consider within a risk assessment for young people, these include risks to health from extreme cold or heat, noise, or vibration. Young people should not be employed for work that is beyond their physical or psychological capacity.

43 You must let the parents/guardians of any students (and employees) below the minimum school leaving age know the key findings of the risk assessment and the control measures taken before young people start work or work experience. See the *Young people at work* section of the HSE website for more information.

Pregnant and breastfeeding workers

44 When you are undertaking risk assessments, consider any specific risks to women of childbearing age who could become pregnant, along with any risks to new and expectant mothers. This is a requirement of the Management of Health and Safety at Work Regulations 1999.

45 Employees do not have to inform their employer that they are pregnant or breastfeeding, but it is important (for their own and their child's health and safety) to provide their employer with written notification as early as possible.

46 When you receive written notification that one of your employees is pregnant or is breastfeeding, you must carry out a specific risk assessment. Take steps to ensure that they are not exposed to any significant risks. Some of the more common risks you should consider are:

- lifting/carrying heavy loads;
- standing or sitting for long lengths of time;
- work-related stress;
- workstations and posture;
- long working hours; and
- excessively noisy workplaces.

47 Where the risk assessment identifies risks, temporarily adjust the working conditions and/or hours of work. If it is not reasonable to do so, or would not avoid the risk, then:

- offer suitable alternative work (at the same rate of pay) if available, or, if that is not feasible;
- suspend the individual from work on paid leave for as long as necessary to protect the health and safety of the individual and their child.

48 See *A guide for new and expectant mothers who work* INDG373⁵ for further information.

Agency workers

49 Employment agencies and warehouse operators who hire from agencies have a shared duty to protect the health and safety of agency workers. They should co-operate and co-ordinate with each other to ensure that the risks to agency workers are adequately managed.

50 Where agency workers are used, you should consider them within your risk assessments. Take into account their lack of experience and familiarity with the work. The same health and safety standards that apply to permanent employees should also apply to agency workers.

51 An employer's health and safety duties towards agency staff cannot be passed to another party by civil contracts. Employment agencies and warehouse employers should ensure that there is a clear understanding of who is responsible for the day-to-day management of the health and safety of agency staff; it is recommended that this agreement is recorded in writing.

52 You can find more information on agency workers on the HSE website and Department of Trade and Industry (DTI) Business Link website (see *Further information*).

Workers who do not have English as their first language

53 The warehousing industry employs many workers who do not have English as their first language. You should ensure that there are suitable methods in place to clearly communicate training and instructions to these groups of employees, as well as adequate supervision arrangements.

Contractors

54 If contractors are working on site, eg carrying out racking maintenance or doing roof repairs, it is not sufficient to assume that they are competent and working safely.

55 Contractors' competence and experience should be established before contracting them and once they are on site, make sure that they are in fact working to a safe system of work. You should also make sure that the activities carried out by the contractor will not endanger other employees, eg an engineer servicing a conveyor could remove a guard for access and not replace it, or an electrician working at height could drop a tool onto workers below.

56 See *Working together: Guidance on health and safety for contractors and suppliers* INDG268⁶ for more information.

Involving employees' health and safety representatives

57 Workers are the people who know the most about the jobs they do. Therefore, it makes sense that they should play an active part in developing safe, practical systems of work. That is why there is a legal duty to consult with workers and/or their representatives.

58 There is evidence that points to the advantages of involving workers in health and safety risk management. By introducing worker involvement, you will be making a significant contribution to:

- developing a positive health and safety culture;
- reducing accidents and ill health and their associated costs;
- meeting customer demands and maintaining credibility; and
- complying with legal requirements.

59 In short, workplaces where workers are involved in taking decisions about health and safety are safer and healthier workplaces.

60 To encourage effective worker involvement, you should make sure that your health and safety policy statement specifies that everyone has a positive role to play. It should give a clear commitment by senior management to actively involve the workforce – including part-time and agency workers – as part of a developing health and safety culture.

61 Where there is a recognised trade union, you must consult with the safety representatives elected by the trade union. Trade union safety representatives are an important source of health and safety knowledge and should be actively engaged in any scheme to build worker involvement. They can play a key role in motivating workers to participate. Their trade union training as safety representatives and access to independent advice on health and safety matters mean that they can add value to your health and safety management.

62 See also *Consulting employees on health and safety: A guide to the law* INDG232.⁷

Employees' responsibilities

63 Employees also have health and safety responsibilities for themselves and colleagues. They must:

- work in accordance with the training and instruction given by their employer;
- report situations they believe to be unsafe; and
- not do anything that could endanger themselves or other people.

Occupational health

64 In 2005/06 there were 24 million working days lost due to workplace ill health in the UK. The most common causes were stress-related illness (10.5 million days) and musculoskeletal disorders (9.4 million days). These are also the main causes of occupational ill health within the storage and warehousing industry.

65 Occupational ill health costs:

- employers, through the loss of experienced staff and reduced productivity of individuals;
- society, where people leave work and go on to long-term incapacity benefits; and
- individual workers and their families, due to the long-term effects of chronic health problems.

66 Occupational health can be more difficult to manage than safety and as a result far more workers suffer from work-related ill health than accidents. Usually the causes and consequences of poor safety at work are immediate and are relatively easy to deal with. Work-related causes of ill health can be more difficult to spot. It can often take some time for symptoms to develop, so the connection between cause and effect is less obvious.

67 For the most common occupational health problems, such as back pain, there may be other causes that have nothing to do with work. Workers may also be unwilling to admit themselves that they have work-related health problems because of fears about their job or the stigma attached to certain types of illness.

68 Knowledge about the most effective solutions to work-related health problems can also be limited. Some of the larger businesses in the industry employ specialist occupational health staff, usually with a medical background. However, for most organisations, especially small businesses, access to reliable medical advice on occupational health is very limited.

69 Improving occupational health management is not as difficult as many people think. Businesses don't need to set up specialist departments or pay for expensive medical advisors to control it on a day-to-day basis. The vast majority of occupational ill health results from a few basic causes. These can be controlled by management and workers working together to identify practical control measures that are suitable for their workplace.

Managing occupational health

70 There are three broad issues to consider when developing an effective occupational health management programme. These are:

- preventing and managing the risk;
- rehabilitation; and
- health promotion.

71 There is a legal and moral responsibility on the employer to do what is reasonably practicable to prevent work-related ill health. As well as complying with general duties under the Health and Safety at Work etc Act 1974, some more specific legal duties are relevant to common health problems in the workplace, eg the Control of Substances Hazardous to Health Regulations 2002 (COSHH) deal with hazardous chemicals, dusts and fumes.

Preventing and managing the risk

72 As with any health and safety issue, a hierarchy of control measures should be followed. Where possible, removing the hazard is the best option. Reliance on individual protection through personal protective equipment (PPE) should normally be a last resort.

73 Identifying work-related health risks may not be straightforward, but there are a number of sources you can use – see paragraphs 74–76. HSE has also produced guidance on the main issues, some of this is available through the HSE website.

Monitoring sickness absence

74 Attendance management has become a major issue for many employers. Information obtained from more tightly managed attendance can be very useful in identifying possible work-related health problems. If there are certain jobs or parts of the workplace where absence is higher, this may be an indication of a problem. High levels of back pain or upper-limb disorder (ULD) symptoms may be associated with certain types of work. However, you may need to exercise some caution when analysing absence patterns, and remember that some personal information is protected by data protection laws. Paragraphs 145–148 give more information on managing sickness absence.

Health surveillance

75 Where there is a clearly identifiable disease or condition linked directly to the work and there is a reliable way of monitoring to detect the condition, health surveillance might be necessary. Examples include hearing tests for people working where there is loud noise and a risk of damage to hearing. Any health records collected through health surveillance must be kept confidential and workers must know what surveillance is being done and why.

Listening to the workers

76 A lot of information can be gained from the workers themselves, but remember that workers may be reluctant to admit to health problems. However, there are ways of gathering their experience or collecting their opinions that can protect confidentiality and ensure a more open response. Trade union safety representatives are often trained in the use of techniques such as body mapping, surveying with discomfort questionnaires, etc.

Rehabilitation

77 Even if you are doing everything possible to prevent people being made ill by work, there will still be occasions when someone does become ill. The initial cause of their health problem may not be work-related but the consequences still need to be managed. It is possible that someone might develop backache or a stress-related illness because of non-work-related factors, but if they work in a job that involves lifting or that is very intensive, then there is a real chance that their work could aggravate the condition and turn it into something far more serious. Failure to manage an episode of ill health could result in more permanent illness and the loss of a valued employee.

Health promotion

78 Health in the workplace is a central part of the government's public health policy. It is keen to see more being done to prevent work-related ill health, and to see the workplace being used as a vehicle for promoting healthier lifestyles.

79 Examples of initiatives that can benefit the employer as well as the employees are:

- promoting healthy eating and offering healthy alternatives in the canteen;
- helping staff to stop smoking; and
- educating staff about drinking and drug use as part of an overall policy on drugs and alcohol.

80 However, health promotion is not a substitute for prevention of work-related ill health. It may be attractive to offer it as a part of the overall health policy, but the primary reason for having such a policy is to make sure that staff are not being made ill, or existing conditions worsened, by the work that they do.

Specialist advice

81 Often the process of managing occupational health only requires good communication between managers and workers. There is not always a need to employ any specialist assistance or expensive experts.

82 Expert advice does not always need to be of a medical nature, eg an ergonomist will be able to advise on musculoskeletal problems.

Musculoskeletal disorders

83 Musculoskeletal disorders (MSDs), such as back pain and upper-limb disorders, are a significant problem for the industry. Paragraphs 348–353 in chapter *Manual handling* give more information on the risks to muscles, joints, tendons and other parts of the musculoskeletal system and how these risks should be managed.

Display screen equipment

84 The Health and Safety (Display Screen Equipment) Regulations 1992 apply to situations where staff use display equipment, such as a visual display unit (VDU), as a significant part of their normal work.

85 The incorrect and excessive use of display screen equipment can lead to upper-limb disorders and visual discomfort. Employers have a duty to:

- assess and reduce risks;
- ensure workstations meet minimum requirements;
- plan work so there are breaks or changes of activity;
- provide eye tests on request; and
- provide health and safety training and information.

86 Aches and pains can be avoided by a variety of simple steps, such as adjusting a chair and VDU equipment to find a comfortable position, using good keyboard and mouse technique, varying activities or taking breaks to avoid sitting in the same position for long periods.

87 Further information can be found in *The law on VDUs: An easy guide* HSG90.⁸

88 There is some equipment that is not covered by the Health and Safety (Display Screen Equipment) Regulations 1992, such as fork-lift truck mounted displays for stock management systems. The general requirement to carry out a risk assessment for this equipment still applies and you should consider the ergonomics of use as part of this risk assessment.

Stress

89 Work-related stress is a major cause of occupational ill health. It is not confined to one industry. Operatives, drivers, supervisors and managers working within the warehousing industry can all be at risk.

90 HSE defines stress as ‘the adverse reaction people have to excessive pressure or other types of demand placed on them’. Pressure is part of work and helps to keep us motivated; however, excessive pressure can lead to stress, which undermines performance, is costly to employers and can make people ill.

Managing occupational stress

91 Employers have a duty to manage occupational stress just like any other health and safety risk. The physical and psychological impact on employees from work-related stressors should be risk assessed. You should look for pressures at work that could cause high and long-lasting levels of stress, decide who might be harmed, and whether you are doing enough to prevent harm.

92 You should take reasonable steps to deal with those pressures identified in your risk assessment. Reducing stress in the workplace does not have to be an expensive process.

The Management Standards approach

93 The Management Standards approach, designed by HSE, helps employers work in partnership with their employees and representatives to undertake risk assessments for stress.

94 The Standards look at six key areas of work that, if properly managed, can help to reduce work-related stress:

- **demands:** including issues like workload, shift patterns and the work environment;
- **control:** how much influence the person has in the way they do their work;
- **support:** including the encouragement, sponsorship and resources provided by the organisation, line management and colleagues;
- **relationships:** including promoting positive working to avoid conflict and dealing with unacceptable behaviour;
- **role:** whether people understand their role within the organisation and whether the organisation ensures that they do not have conflicting roles; and
- **change:** organisational change (large or small), the pace of change and how it is managed and communicated within the organisation.

95 Your risk assessment should start by identifying if there is a problem. You can use existing information to see how your organisation shapes up. Sickness absence or staff turnover data could help, as could any surveys of your employees.

96 The survey tool developed by HSE (available on the HSE website) can also be used to give an indication of performance against the Standards. Remember that where existing data or the HSE survey are used, employees and their representatives should still be consulted to verify the findings and assess what is happening locally.

97 Each hazard should be evaluated and a decision made about who might be harmed and how. A good way to decide what needs to be done is to bring together groups of about six to ten employees as a 'focus group'. Talking to a selection of employees from a specific work group will allow issues from the risk assessment to be explored in more detail, as well as taking into account local challenges and possible solutions.

98 Record the results of the risk assessment in an action plan to implement the solutions agreed with senior management, employees and their representatives.

99 Once you have agreed the action plan, monitor progress and review any action taken to tackle stress. One way to measure progress is to use the survey tool again after a period of time. In addition to any arrangements you have established to talk about stress on a regular basis, consider an annual survey.

100 Despite the precautions taken, some employees may experience work-related stress. There should be adequate systems in place for supporting stressed and distressed members of staff, along with arrangements for rehabilitation.

101 The HSE website gives detailed information on the Stress Management Standards. See also *Real solutions, real people: A managers' guide to tackling work-related stress*⁹ and *Working together to reduce stress at work: A guide for employees*.¹⁰

Stress and order picking

102 There can be potential hazards for occupational stress associated with this type of work. The following guidelines should help manage the risk of stress from order picking:

- Targets set for order picking should be achievable. Staff and their representatives should be involved in setting targets.
- Ideally, individual targets should be set that take account of individual differences that may have an effect on the ability to achieve targets.
- Targets should be clear and transparent to all workers and their personal roles in meeting the targets should be communicated. Avoid ambiguous targets (ie the difference between a minimum acceptable target and the target to be achieved for the day should be made clear where applicable).
- Feedback should be positive as well as negative and pickers should know if they/their team have met their target(s).
- Staff surveys are a useful tool to help gather information on potential stressors. Results of staff surveys should be communicated and acted upon, where appropriate.
- Electronic order picking has the potential to be used as a monitoring system, not just a picking system. Order pickers should be clear as to the intended purpose and use of the system. If it is to be used for performance monitoring activities, then this should be done with staff representative involvement and made explicit. Order pickers should know exactly when they will be monitored and any potential ramifications.
- Consider providing occupational health support, where appropriate.

Shift work

103 Shift work is common in the warehousing industry. Poorly designed shift-working arrangements and long working hours that do not balance the demands of work with time for rest and recovery can result in fatigue, accidents, injuries and ill health.

104 Shift work is generally considered to be a continuous or semi-continuous pattern of work where one employee takes the work over from another within a 24-hour period and where some or all of the work activity takes places outside of standard daytime working hours (7.00 am to 7.00 pm). This may include evening, night and early morning work, extended hours, weekend working, permanent and rotating shifts, split shifts and overtime.

105 There can be undesirable consequences for those working shifts, particularly night and early morning shifts. These include disruption of the internal body clock, sleeping difficulties and fatigue, which in turn can affect performance, increase the likelihood of errors and accidents at work and in the long term, might affect health and well-being.

106 There is also evidence to suggest that shift workers have an increased risk of digestive and cardiovascular problems.

107 The irregular and often unsociable hours of shift work can also cause problems at home, especially if family and friends are not sympathetic and do not appreciate the toll that shift work may have on someone's health and well-being.

Assessing and managing the risks of shift work

108 You should include the risks associated with shift work in your risk assessments. Paragraphs 22–30 give more information on risk assessment.

109 There are many different shift work schedules and each schedule has different features. This sheer diversity of work and workplaces means that there is no single optimal shift system that suits everyone. However, there are a number of key risk factors in shift schedule design, which you should consider during risk assessment:

- workload;
- work activity;
- direction of shift rotation;
- shift timing and duration;
- the number and length of breaks within a shift;
- rest periods between shifts; and
- the working environment.

110 Site-specific risk factors and risks to people who are not employees should also be considered.

111 Certain groups may be more vulnerable than others. These include young or ageing workers and new or expectant mothers who may not cope so well with shift work and may be more prone to fatigue.

112 *Managing shift work: Health and safety guidance HSG256*¹¹ gives more information on this subject.

Good practice guidelines for shift design

113 Applying, where reasonably practicable, good practice guidelines will help reduce the risks that workers are exposed to by shift working:

- Plan an appropriate and varied workload.
- Offer a choice of permanent or rotating shifts and try to avoid permanent night shifts.
- Rotate shifts every two to three days or every three to four weeks, otherwise adopt forward rotating shifts.
- Avoid early morning starts and try to fit shift times in with availability of public transport.
- Limit shifts to 12 hours including overtime, or up to eight hours for night shifts and/or where the work is demanding, monotonous, dangerous and/or safety critical.
- Encourage workers to take regular breaks and allow some choice as to when they are taken.
- Consider the needs of vulnerable workers, such as young or ageing workers and new or expectant mothers.
- Limit consecutive workdays to a maximum of five to seven days and restrict long shifts, night shifts and early morning shifts to two to three consecutive shifts.
- Allow two nights full sleep when switching from day to night shifts and vice versa.
- Build regular free weekends into the shift schedule.

114 Follow good practice guidelines for the work environment:

- Provide similar facilities as those available during daytime and allow shift workers time for training and development.
- Ensure temperature and lighting is appropriate and adjustable.
- Provide training and information on the risks of shift work and ensure supervisors and management can recognise problems.
- Consider increasing supervision during periods of low alertness.
- Control overtime, shift swapping and on-call duties and discourage workers from taking second jobs.
- Set standards and allow time for communication at shift handovers.
- Encourage interaction between workers and provide a means of contact for lone workers.
- Encourage workers to tell their GPs that they are shift workers and provide free health assessments for night workers.
- Ensure the workplace and surroundings are well lit, safe and secure.

115 You should manage the risks associated with shift work like any other health and safety issue. This includes:

- consulting with workers;
- monitoring the shift work arrangements; and
- periodically reviewing risk assessments.

Working Time Regulations

116 The Working Time Regulations 1998 are also relevant to working patterns. The basic rights and protections that the Regulations provide are:

- a limit of an average of 48 hours a week that a worker can be required to work (though workers can choose to work more if they want to);
- a limit of an average of eight hours work in 24 that night workers can be required to work;
- a right for night workers to receive free health assessments;
- a right to 11 hours rest a day;
- a right to a day off each week;
- a right to an in-work rest break if the working day is longer than six hours; and
- a right to four weeks paid leave per year.

117 Note that only some parts of these Regulations are enforced by HSE and local authorities – more information can be found on the HSE website.

Noise

118 Generally, noise is not a major issue in warehousing. However, there can be sources within warehouses that can generate noise levels that could cause hearing damage. You should ensure that where there is a noisy environment, the risks to your employees' hearing are managed.

119 Sources of noise in warehouses can include: mechanical handling equipment, automated systems, conveyors, radios, compactors and equipment within plant rooms (including refrigeration equipment).

120 Whether you have a noise problem or not will depend on how loud the noise is and how long people are exposed to it. As a simple guide, you will probably need to do something about the noise if any of the following apply to parts of your warehouse:

- Is the noise intrusive – as on a busy street, or in a crowded restaurant – for most of the working day?
- Do employees have to raise their voices to carry out a normal conversation when about 2 m apart – for at least part of the day?
- Do employees use noisy powered tools or machinery for more than half an hour each day?
- Do employees work in a noisy environment, such as a refrigeration plant room?
- Are there ‘banging’ or ‘crashing’ noises due to impacts?

121 Remember that noise can cause other problems such as disturbance, interference with communications and stress.

122 The Control of Noise at Work Regulations 2005 require employers to prevent or reduce risks to health and safety from exposure to noise at work. These Regulations require employers to:

- assess the risks to employees from noise at work;
- take action to reduce the noise exposure that produces those risks;
- provide employees with hearing protection if the noise exposure cannot be reduced enough by using other methods;
- make sure the legal limits on noise exposure are not exceeded;
- provide employees with information, instruction and training; and
- carry out health surveillance where there is a risk to health.

123 The Regulations require employers to take specific action at certain action values, which relate to the levels of your employees’ exposure to noise averaged over a working day or week, and the maximum noise (peak sound pressure) that employees are exposed to in a working day.

124 Further information can be found in *Noise at work: Guidance for employers on the Control of Noise at Work Regulations 2005* INDG362.¹²

Control of substances hazardous to health

125 Using chemicals or other hazardous substances within warehouses can put people’s health at risk. The Control of Substances Hazardous to Health Regulations 2002 (COSHH) require employers to control exposure to hazardous substances to prevent ill health. Effects from hazardous substances can range from mild eye irritation to chronic lung disease or, on occasion, death.

Hazardous substances and their effects

126 Hazardous substances include:

- substances used directly in work activities (eg adhesives, battery acid, pest control, paints, cleaning agents);
- substances generated during work activities (eg fumes from industrial trucks or spilled products);
- naturally occurring substances (eg dust in certain concentrations); and
- biological agents such as bacteria and other microorganisms.

127 Effects of hazardous substances include:

- skin irritation or dermatitis as a result of skin contact;
- asthma as a result of developing an allergy to substances used at work;
- loss of consciousness as a result of being overcome by toxic fumes;
- cancer, which may appear long after the exposure to the chemical that caused it; and
- infection from bacteria and other microorganisms (biological agents).

Substances COSHH does not apply to

128 COSHH applies to virtually all substances hazardous to health except:

- asbestos (see paragraphs 208–215) and lead (paragraph 136), which have their own regulations;
- substances which are hazardous only because they:
 - are radioactive;
 - are at high pressure;
 - are at extreme temperatures; or
 - have explosive or flammable properties (other regulations apply to these risks); and
- biological agents that are outside the employer's control, eg catching an infection from a work colleague.

Hazardous situations

129 Examples of situations within a warehouse that might have a risk of exposure to hazardous substances include:

- leaks from packages and containers;
- accidental spillage;
- puncture of packages or containers, eg by the forks of a lift truck;
- subdividing substances or breaking down from bulk storage;
- generating hazardous substances on site, eg exhaust fumes and accidental mixing of incompatible products during storage; and
- an accidental leak of a refrigerant (paragraphs 698–705 give more information on this).

130 Remember to consider people involved in cleaning and maintenance tasks – high exposures can occur during this type of work. Also consider certain groups of people who could suffer more from exposure than others, eg expectant mothers or individuals with a suppressed immune system.

What the law requires

131 Employers have to protect employees and other people who may be exposed to hazardous substances in the workplace. The COSHH Regulations place specific duties on employers.

132 There are eight steps that should be taken to comply with COSHH:

- Step 1 Assess the risks to health** from hazardous substances used in or created by workplace activities.
- Step 2 Decide what precautions are needed.** You must not carry out work that could expose your employees to hazardous substances without first considering the risks and the necessary precautions, and what else you need to do to comply with COSHH.
- Step 3 Prevent or adequately control exposure.** You should prevent your employees being exposed to hazardous substances. Where preventing exposure is not reasonably practicable, then you must adequately control it.
- Step 4 Ensure that control measures are used and maintained properly,** and that safety procedures are followed.
- Step 5 Monitor the exposure of employees to hazardous substances,** where this is necessary.
- Step 6 Carry out appropriate health surveillance** where the assessment has shown this is necessary or where COSHH sets specific requirements.
- Step 7 Prepare plans and procedures** to deal with accidents, incidents and emergencies involving hazardous substances, where necessary.
- Step 8 Ensure employees are properly informed, trained and supervised.** You should provide your employees with suitable and sufficient information, instruction and training.

133 If you have five or more employees, you must make and keep a record of the main findings of your COSHH assessment.

134 The COSHH section of the HSE website gives further information. See also *COSHH essentials* HSG193,¹³ and *COSHH: A brief guide to the Regulations* INDG136.¹⁴

135 Chapter *Storage of packaged dangerous substances* gives more information on the storage of dangerous substances.

Lead

136 Compounds of lead may be stored or handled in a way that is subject to the Control of Lead at Work Regulations 2002, eg breaking down from bulk. In these circumstances, you should carry out a risk assessment to determine whether exposure is significant and if further action is necessary to control the risk of exposure to lead. If in doubt, seek specialist advice.

Vibration

137 Exposure to vibration at work can occur in two main ways:

- hand-transmitted vibration (known as hand-arm vibration or HAV);
- vibration transmitted through the seat or feet (known as whole-body vibration or WBV).

138 When carrying out your risk assessments, you should consider your employees' exposure to vibration. This is not one of the most common causes of ill health within the warehousing industry, but there are occasions where employees' health can be put at risk from exposure to vibration. When this is the case, you should control the risk.

Hand-arm vibration

139 Warehouse workers are not typically exposed to hand-arm vibration. However, some ancillary workers within the warehouse, such as workshop engineers, may be exposed when operating hand-held power tools such as workshop equipment (eg impact drills or nail guns), high-pressure water jets, or ice scarifiers. Exposure may result in a range of health effects collectively known as hand-arm vibration syndrome (HAVS). The most well-known health effect is vibration white finger, but other effects include damage to sensory nerves, muscles and joints in the hands and arms.

Whole-body vibration

140 Under certain circumstances, drivers of some mobile machines (including industrial trucks) may be exposed to whole-body vibration and shocks that are associated with back pain. Other work factors, such as posture and heavy lifting, are also known to contribute to back problems for drivers.

141 High exposures to whole-body vibration could occur where vehicles designed for smooth surfaces are driven on poor surfaces, eg when shunter vehicles or lift trucks with no wheel suspension or with solid tyres are used on a cracked or uneven yard.

What the law requires

142 If your employees are exposed to vibration, you will need to decide if there is likely to be a significant risk. If there is a risk, you need to assess who is at risk and to what degree.

143 The Control of Vibration at Work Regulations 2005 require that employers:

- assess the vibration risk to employees;
- decide if they are likely to be exposed above the daily exposure action value (EAV), and if they are, introduce a programme of controls to eliminate risk or reduce exposure to as low a level as is reasonably practicable. Also provide health surveillance (regular health checks) to those employees who continue to be regularly exposed above the action value or otherwise continue to be at risk;
- decide if they are likely to be exposed above the daily exposure limit value (ELV) and, if they are, take immediate action to reduce their exposure below the limit value;
- provide information and training to employees on health risks and the actions they are taking to control those risks;
- consult trade union safety representatives or employee representatives about the risks and what they plan to do;
- keep a record of their risk assessments and control actions;
- keep health records for employees under health surveillance;
- review and update risk assessments regularly.

144 Further information can be found in *Control the risks from hand-arm vibration: Advice for employers on the Control of Vibration at Work Regulations 2005* INDG175¹⁵ and *Control back-pain risks from whole-body vibration: Advice for employers on the Control of Vibration at Work Regulations 2005* INDG242.¹⁶

Managing sickness absence and return to work

145 Long-term sickness absence represents a significant burden on both employers and employees. It involves a relatively small number of people but has a significant cost. For employers this includes sick pay, reduced productivity and unnecessary recruitment. For employees this includes reduced earnings, job loss for some and an increased workload for colleagues.

146 You are encouraged to have systems in place to help your employees to return to work after a long-term sickness absence, including:

- a policy making a commitment to helping employees return to work;
- arrangements for recording sickness absence, as appropriate;
- keeping in contact with employees on sick leave and letting them know what is expected from them;
- arrangements for return-to-work interviews and return-to-work plans;
- supporting return to work, eg in the form of adjustments to the workplace or changes to systems or hours of work wherever possible and redeployment where necessary;
- ensuring that employees who have suffered ill health, injury or disability are treated fairly, equally and consistently; and
- provision of leave and time off to aid return to work or to attend medical appointments.

147 It is recommended that you develop these systems in consultation with your employees, their trade unions or other representatives. For larger employers, these systems could be documented in a return-to-work policy and procedures.

148 HSE has some useful guidance on the management of sickness absence and retention of staff who may have developed a health problem. More information can be found on the HSE website. See also *Managing sickness absence and return to work: An employer's and manager's guide* HSG249,¹⁷ and *Managing sickness absence and return to work in small businesses* INDG399.¹⁸

Environment and welfare

149 It is important to provide a safe and healthy environment for your employees and visitors, along with adequate welfare facilities. This should be the starting point for good health and safety management within your warehouse.

Design and layout

150 Warehouses should be designed and laid out to allow for the safe movement of goods, materials and people. Good design and layout can help reduce accidents, including those involving vehicles and people slipping and tripping.

151 The movement of goods and materials involves the use of a wide range of vehicles and accounts for a large proportion of accidents in warehouses. It is important to have a safe system of traffic management. This should include methods and procedures for arrival, reception, unloading, loading and movement of vehicles within the premises. People and vehicles should be segregated as far as is reasonably practicable.

152 Chapter *Vehicles in and around the warehouse* gives more information on workplace transport.

153 When thinking about design and layout, consider the following areas:

- storage areas, aisles and gangways;
- pedestrian traffic routes;
- staircases and ramps; and
- emergency escape routes.

Workrooms – dimensions and space

154 Sufficient floor area should be available to enable workers to move freely within a room. A minimum space of 11 m³ per person (based on a height of 3 m) is recommended, but this may need to be increased if a large proportion of the room is taken up by furniture.

Floors and traffic routes

155 Floors and traffic routes should be constructed and designed to withstand the use to which they may be subjected, eg physical damage from lift trucks and wheeled equipment or corrosion from chemical substances.

156 Floors should also be capable of bearing the general overall load to which they may be subjected and any point loading from stock, either with or without pallet racking. Traffic routes should have adequate strength and stability, taking account of the traffic passing over them. Floors should not be overloaded.

157 Deep holes into which people may fall should be securely fenced or covered.

158 Chapter *Work at height* gives information on mezzanine floors.

159 Storage areas, aisles and gangways should be clearly marked out on the floor. Gangways should be wide enough to ensure that mechanical handling equipment can be easily manoeuvred.

160 The surfaces of floors and traffic routes should be free from any hole, slope, or uneven or slippery surface which is likely to:

- cause a person to slip, trip or fall;
- cause a person to drop or lose control of anything being lifted or carried;
- cause instability or loss of control of vehicles and/or their loads.

161 Slopes should not be steeper than necessary. Moderate and steep slopes, and ramps used by people with disabilities, should be provided with a secure handrail where necessary.

162 Floors and traffic routes play an important part in managing the risk of slips and trips. See chapter *Slips and trips* for specific information.

163 Where a temporary obstruction is unavoidable and is likely to be a hazard, prevent access or take steps to warn people or drivers of the obstruction, eg by using hazard cones.

164 Where furniture or equipment is being moved within a workplace, it should if possible be moved in a single operation and should not be left in a place where it is likely to be a hazard. Vehicles should not be parked where they are likely to be a hazard.

Fire safety

165 A fire occurring in a warehouse can have serious implications for life and property. You should take steps to avoid fires and to ensure people's safety if a fire does start.

166 The local fire and rescue authority will enforce fire safety in most premises, including warehouses.

167 To meet the requirements of the fire safety legislation, you are required to undertake a fire risk assessment to help you ensure that your fire safety procedures, fire prevention measures and fire precautions (plans, systems and equipment) are all in place. The five steps of a fire risk assessment are:

- Step 1 identify fire hazards** (sources of ignition, fuel and oxygen);
- Step 2 identify people at risk;**
- Step 3 evaluate, remove, reduce and protect from risk** (evaluate, remove or reduce fire hazards and evaluate, remove or reduce the risks to people);
- Step 4 record, plan, inform, instruct and train** (record significant findings and action taken, prepare an emergency plan, inform and instruct relevant people, and provide fire safety training for your staff); and
- Step 5 review and revise your assessment as necessary.**

168 You are advised to develop a long-term workable and effective strategy to reduce hazards and the risk of a fire starting. At its simplest, this means separating flammable and combustible materials from ignition sources. You need to consider:

- housekeeping, eg preventing the accumulation of combustible materials, keeping waste material in suitable containers before removal from the premises and developing a plan to manage risks that arise;
- storage of combustible materials. Ensure you have sufficient storage areas for your needs and ensure storage areas are adequately controlled and monitored;
- the storage, display and use of dangerous substances, including flammable liquids, gas cylinders, flammable dusts, aerosols, fireworks and explosives;
- equipment and machinery. Ensure that it is correctly cleaned, maintained and used;
- electrical equipment is a significant cause of accidental fires in factories and warehouses. It should be installed and maintained in a safe manner by a competent person, and subject to regular visual inspections and more periodic detailed portable appliance testing (PAT). Incorrect use, congested ventilation or positioning near combustible materials may all allow the equipment to overheat;
- smoking as a potential for ignition sources;
- managing building work and alterations, since fires are more frequent when buildings are undergoing refurbishment or alteration;
- whether any part of the existing layout and construction of the warehouse lends itself to easy paths through which smoke and fire may spread – and what you can do to prevent it, eg false ceilings can be fire-stopped, or unsealed holes in walls can be filled;
- particular hazards in corridors and stairways used as escape routes. Look for fire hazards, obstructions, blocked/locked fire exits;
- restricting the spread of fire and smoke, eg through the use of sprinkler systems, or roof vents to allow the escape of smoke;
- arson, which is a significant risk, particularly if combustible rubbish is stored alongside the building, entry points to the building are not secure or there is a reason to believe there is a risk from individuals or groups;
- help for members of the public or people with special needs, such as those with a disability.

169 The Department for Communities and Local Government and the Scottish Executive have published guidance¹⁹ to help you meet the requirements of fire safety legislation.

General housekeeping

170 Keep work areas, offices, mess rooms, storage areas, aisles and gangways, washing and toilet facilities clean and tidy at all times. Poor housekeeping can significantly increase the risk of other accidents, eg slips and trips.

Workplace temperature

171 The temperature in warehouse operations should provide reasonable comfort without the need for special clothing.

172 Typically, the temperature should be at least 16 °C. Where the work involves severe physical effort, the temperature should be at least 13 °C. However, these temperatures may not ensure reasonable comfort. Other factors, such as air movement and relative humidity, should also be considered. (These temperatures refer to readings taken using an ordinary dry bulb thermometer, close to workstations, at working height and away from windows.)

173 In warehouses, it may be impractical to maintain these temperatures because of specific storage temperature requirements, or because of the nature of the building (eg in buildings that have to be open to the outside). In these cases, take all reasonable steps to achieve a temperature that is as close as possible to a comfortable level.

174 See also chapter *Temperature-controlled storage*.

175 If food or other products have to be kept at low temperatures, before chilling the whole workplace consider keeping only the product chilled. The aim is to chill the food not the workplace, so consider:

- enclosing or insulating the product;
- pre-chilling the product;
- keeping chilled areas as small as possible; or
- exposing the product to workplace temperatures as briefly as possible.

176 Where a reasonably comfortable temperature cannot be achieved throughout your warehouse, provide local heating or cooling (as appropriate).

177 There are no specific upper temperature limits. However, the requirement for temperatures in the workplace to be reasonable applies. In extremely hot weather, fans and increased ventilation may be used instead of local cooling.

178 Insulated duckboards or other floor coverings may be provided where workers have to stand for long periods on cold floors, unless special footwear is provided which prevents discomfort. Draughts should be excluded and self-closing doors installed, where such measures are practicable and would reduce discomfort.

179 Where workers are exposed to temperatures that do not give reasonable comfort, provide suitable protective clothing and rest facilities. The provision of protective clothing should be considered as a last resort.

180 In parts of the workplace other than workrooms, such as sanitary facilities or rest facilities, the temperature should be reasonable. Changing rooms and shower rooms should not be cold.

181 Where people are required to work in normally unoccupied rooms such as storerooms, other than for short periods, temporary heating may be provided (if necessary) to avoid discomfort.

182 More information on heating and thermal comfort can be found on the HSE website.

Ventilation

183 Most warehouses where loading/unloading doors are open during the working day will not usually require any special ventilation arrangements.

184 However, specific ventilation requirements may be necessary for the storage of some materials or where combustion equipment is used inside the warehouse. See paragraphs 187–192 for more information.

185 A warehouse containing combustion equipment or plant, such as oil- or gas-fired heaters and lift trucks with internal combustion engines, will require air for the combustion process and, if the plant or equipment is not flued, to dilute hazardous combustion products to an acceptable level.

Gas- and oil-fired equipment

186 Fresh air requirements for gas- and oil-fired equipment will depend on how the equipment is flued. If ventilation is inadequate, carbon monoxide levels can increase rapidly, increasing the risk of carbon monoxide poisoning from unflued combustion equipment. Unflued space heaters are not recommended, use room-sealed appliances where ventilation is difficult.

Internal combustion engines

187 Industrial trucks powered by internal combustion engines (petrol, diesel, liquefied petroleum gas (LPG)) emit hazardous exhaust gases and particulates. If these trucks are used inside your warehouse, you may need to provide adequate ventilation to remove exhaust fumes.

188 Ventilation requirements will vary according to:

- the number of industrial trucks being used;
- the volume of the warehouse or operating area;
- the type of fuel used (LPG is considered to be a cleaner fuel); and
- the condition of the engine (proper engine maintenance will reduce toxic emissions).

189 It is also important that engines are properly maintained. Exhaust fumes may be significantly reduced by the use of filter systems or catalytic converters. However, these systems are not a substitute for providing adequate ventilation.

190 In some situations, eg where large numbers of industrial trucks powered by internal combustion engines are used, your risk assessment under the Control of Substances Hazardous to Health Regulations (COSHH) may indicate the need for action to reduce the risk. Paragraphs 132–133 give more information on COSHH assessments.

191 There may be occasions where monitoring for the presence of gases such as carbon monoxide could be helpful either for establishing if there is a problem or for ensuring that the control measures are adequate.

192 Industrial trucks powered by internal combustion engines of any type should not be used in any workspace where the lack of ventilation would lead to a build-up of hazardous fumes.

Windows, skylights and ventilators

193 The means of opening windows, skylights etc should not give rise to injury and, when open, the position should not be likely to expose anyone to a risk.

194 The bottom edge of opening windows should normally be at least 800 mm above ground level, unless a suitable barrier is provided.

195 All windows and skylights should be designed and constructed to enable them to be cleaned safely, eg with central pivots.

Weather-related conditions

196 You should take reasonable steps to control your employees' exposure to external weather, eg in the winter.

197 Protect external doorways used by mechanical handling equipment from adverse weather conditions, eg by hinged rubber doors with vision panels, plastic strip curtains.

198 Correctly designed and operated doorways can also help manage workplace temperatures.

Transparent or translucent doors, gates and walls

199 You may need to prevent pedestrians from walking into transparent materials which are not readily visible or apparent. Measures include the use of safety materials, appropriate markings, screens and barriers.

Lighting

200 Good lighting, whether natural or artificial, is vital in promoting health and safety at work. It also has operational benefits, for example making it easier to read labels. In all working and access areas, sufficient lighting should be provided to enable work activities to be carried out safely, shielded from excessive heat or glare. The level and type of lighting depends on:

- the type of work being carried out; and
- the hazards associated with it.

201 Recommended luminance for different areas of a warehouse are given in Table 1. Average luminance is for the work area as a whole. Minimum measured luminance is the minimum permitted at any position within the work area. Where the work or task is predominantly on one plane or vertical, the recommended luminance is intended for that plane.

202 In warehouses there can be considerable obstruction to lighting, eg from racking. It is therefore important to arrange lighting to avoid shadows.

203 Higher levels of luminance may be required where work requires perception of fine detail.

204 The relationship between the lighting in the work area and adjacent areas is important; large differences in luminance may cause visual discomfort or affect safety in places where there are frequent movements. Table 2 gives minimum ratios of luminance for adjacent areas.

205 Lighting should be sufficient to enable people to move from place to place safely. Stairs should be well lit.

206 Where the failure of artificial lighting might expose workers to danger, provide emergency lighting that is automatically triggered by a failure of the normal lighting system.

207 Further details can be found in *Lighting at work* HSG38.²⁰

Asbestos management

208 Asbestos is a term used for fibrous forms of several naturally occurring minerals. Breathing in asbestos fibres can lead to asbestos-related diseases.

209 The three main types of asbestos that have been commercially used are:

- crocidolite (blue asbestos);
- amosite (brown asbestos); and
- chrysotile (white asbestos).

210 All forms are dangerous, with blue and brown asbestos known to be more hazardous than white.

211 Asbestos was used extensively as a building material in Great Britain from the 1950s through to the mid-1980s. Although some of this material has been removed over the years, there are many thousands of tonnes of asbestos still present in buildings.



Figure 3 Good lighting

212 At least 3500 people in Great Britain die each year from mesothelioma and asbestos-related lung cancer as a result of past exposure to asbestos. There is a long delay between first exposure to asbestos and the start of disease. This can vary between 15 and 60 years and annual numbers of deaths are predicted to go on rising into the next decade.

213 Employers are required to:

- identify the presence of asbestos in buildings;
- identify all elements of its condition that impact on its potential to cause harm;
- assess the risk that is presented, eg if it is likely to release fibres; and
- take action to safely manage the risk.

214 Asbestos is only dangerous when disturbed. If it is safely managed and contained it does not present a health hazard. Do not remove asbestos unnecessarily. Removing it can be more dangerous than simply containing it.

215 There are several HSE publications available on the subject of asbestos, listed on the asbestos section of the HSE website. You are advised to read these, or to seek professional assistance if your workers are at risk of exposure to it.

Legionella

216 Legionella is the bacteria that can cause legionnaires' disease. This bacteria can become a problem where water stands for long periods at lukewarm or warm temperatures in tanks or little-used pipes. It can affect people through inhalation of water droplets or mist.

217 A water temperature range of 20 °C to 45 °C and the presence of sludge, rust, algae and organic matter in water tanks also increase the risks. The following water systems can present a legionella risk:

- air-conditioning systems;
- hot water systems with a volume of more than 300 litres of hot water;
- cold water storage systems; and
- evaporative condensers and cooling towers.

218 Water systems that could harbour legionella bacteria must be assessed. The following precautions will reduce the risk of outbreaks of legionella:

- Hot and cold water supplies:
 - design cisterns and pipework to ensure that water does not stand undisturbed for long periods;
 - provide cistern covers to prevent entry of foreign bodies;
 - inspect, clean and disinfect cisterns as appropriate to the risk assessment requirements;
 - insulate cold water tanks and pipes in warm spaces; and
 - set thermostats to store water at 60 °C minimum and circulate at 50 °C;
- Air-conditioning systems:
 - regular inspection and maintenance – determined by local conditions;
 - cleaning and disinfection – frequency determined by local conditions; and
 - treat water to prevent scale, corrosion and growth of microbes.

219 Records of the system operating and maintenance arrangements and copies of invoices and reports by inspection, maintenance and repair contractors should be kept.

Table 1 **Average luminance and minimum measured luminance for different areas of a warehouse**

Activity	Examples of typical locations/type of work	Average luminance (lux)	Minimum measured luminance (lux)
Movement of people, machines and vehicles	Lorry park, corridors, circulation routes	20	5
Movement of people, machines and vehicles in hazardous areas. Rough work not requiring any perception of detail	Loading bays	50	20
Work requiring limited perception of detail	General warehouse operations	100	50
Work requiring perception of detail	Offices	200	100

Table 2 **Minimum ratios of luminance for adjacent areas**

Situations to which recommendations applies	Examples of typical location	Luminance <i>Working area : Adjacent area</i>
Where each task is individually lit and the area around the task is lit to a lower illuminance	Local lighting in an office	5 : 1
Where two working areas are adjacent, but one is lit to a lower illuminance than the other	Localised lighting in a works store	5 : 1
Where two working areas are lit to different luminance and are separated by a barrier, but there is frequent movement between them	An internal storage area and a loading bay outside	10 : 1

220 All buildings containing an evaporative condenser or cooling tower must be notified to the local authority. Subsequent change to the nature of the equipment or its use must also be notified.

Welfare facilities

Toilet and washing facilities

221 Toilets should be provided in adequately lit and ventilated rooms, and kept clean and in good repair. Suitable washing facilities should be provided in the vicinity of every toilet and changing room and should include a supply of clean hot and cold water, soap or means of cleaning, and towels or means of drying. Separate facilities should be provided for men and women unless they are in a room that is lockable from the inside and the facilities are intended for use by only one person at a time.

222 Tables 3 and 4 show the minimum number of toilets and washbasins that should be provided.

223 Toilets should be:

- kept clean and properly maintained;
- well ventilated and lit, and not opening directly into a workroom;
- under cover and partitioned off for privacy, with suitable doors and fastenings;
- readily accessible from workrooms; and
- screened so that urinals are not visible when the door to the room is open.

224 Provide washing facilities that are both adequate and suitable. Provide at least one washbasin for each toilet. In some warehouses, eg where dirty materials or substances are handled, more washbasins will be required. Washing facilities should be:

- kept clean and properly maintained;
- provided with running hot and cold water together with soap or other proprietary hand cleaner and suitable drying facilities; and
- provided at convenient locations that are sufficiently lit.

225 It is recommended that toilet and welfare facilities are provided or made available for use by visiting drivers, both male and female.

Facilities for changing clothes

226 If work clothing becomes wet in the course of work, you may need to provide facilities for drying.

227 If special clothing (eg overalls, a uniform, thermal clothing etc) is worn for work purposes, you should provide changing facilities. Changing rooms should be appropriate for the number of people expected to use them. A changing room should:

- be readily accessible;
- contain, or lead directly to, clothing storage and washing facilities;
- provide seating;
- provide a means for hanging clothes – a hook or peg may be sufficient; and
- be separate for men and women and ensure the privacy of the user.

228 Take steps to stop employees' own clothing getting dirty or wet or coming into contact with work-soiled clothing or getting dirty or wet. This can be done by providing separate storage for clean and contaminated clothing that is well ventilated and allows wet clothing to be hung up to dry out during the course of the day.

Table 3 **Number of toilets and washbasins**

Number of people at work	Number of toilets	Number of washbasins
Up to 5	1	1
6 to 25	2	2
26 to 50	3	3
51 to 75	4	4
76 to 100	5	5

Table 4 **Toilets used by men only**
(as an alternative to number of toilets column in Table 3)

Number of men at work	Number of toilets	Number of urinals
1 to 15	1	1
16 to 30	2	1
31 to 45	2	2
46 to 60	3	2
61 to 75	3	3
76 to 90	4	3
91 to 100	4	4

Accommodation for clothing

229 Provide accommodation for personal clothing and clothing worn at work (separate for work clothing, which may become dirty, damp or contaminated). Accommodation should be secure against theft and maintained in secure and working order.

Facilities for rest and to eat meals

230 There should be a suitable seating area for workers to use during breaks – it needs to be clean and located where food will not get contaminated. Washing facilities should be nearby, and a means of heating food or water for hot drinks. Good hygiene standards should be maintained.

Drinking water

231 Provide an adequate supply of drinking water, which is accessible to all workers, the tap being marked to indicate its suitability for drinking (or alternatively a source of non-drinking water being indicated as such). Suitable containers should be supplied for drinking purposes – employers cannot charge for this.

232 Drinking supplies should not be provided in toilet accommodation, ie should not be within a toilet cubicle or close to a urinal.

Personal protective equipment (PPE)

233 Personal protective equipment (PPE) can be used for lots of different purposes and includes both protective clothing (such as overalls, waterproof equipment, gloves, safety footwear, helmets etc) and protective equipment (such as eye protectors and ear protectors).

234 PPE should not be used as a substitute for other methods of risk control. It should always be regarded as a 'last resort' means of preventing or controlling exposure to hazards to safety and health. This means that you must consider other methods of controlling exposure before taking the decision to use PPE. In some situations, however, it will be necessary to provide protective clothing and/or equipment. This can include outdoor clothing, eg a waterproof and insulated high-visibility jacket.

235 Take into account the demands of the job when selecting PPE, consider;

- the physical effort required to do the job;
- the methods of work;
- how long the PPE needs to be worn;
- requirements for visibility and communication; and
- compatibility of PPE where more than one item is required.

236 The aim should always be to choose equipment that will give minimum discomfort to the wearer. Uncomfortable equipment is unlikely to be worn properly.

237 There will be considerable differences in the physical dimensions of different workers and therefore more than one type or size of PPE may be needed. There is a better chance of PPE being used effectively if it is accepted by each wearer. You should therefore consult with workers who have to use PPE and involve them in selecting and specifying the equipment.



Figure 4 Locker room

Slips and trips

238 Slip and trip accidents can happen anywhere. They are often seen as trivial and ‘just one of those things’, but this is not the case – most slip and trip accidents can be avoided.

239 Within the storage and warehousing industry, slips and trips are a serious problem. They are responsible for a third of major injuries (resulting in broken bones, hospitalisation etc) and a fifth of over-3-day absence injuries.

240 The cost to the individual from these accidents is great; there is the pain from injury, reduced quality of life, worry and stress. The cost to employers is also high, with key staff absent, increased insurance costs, production delays, fines and perhaps loss of image.

241 You can and should create a work environment and culture where slips and trips are much less likely to happen. To achieve this there are many simple and cost-effective steps you can take.

What the law says

242 The Workplace (Health, Safety and Welfare) Regulations 1992 place duties on employers to ensure that the workplace is safe and maintained in good order. Floors and traffic routes should:

- be suitable for the purpose for which they are used;
- be kept free from holes and unnecessary slopes;
- not be uneven or slippery to any extent that could cause someone to slip, trip or fall;
- have effective drainage where necessary;
- be kept free from obstructions, articles or substances which could cause someone to slip, trip or fall; and
- have suitable and sufficient lighting.

243 These Regulations and the accompanying Code of Practice²¹ also have requirements for housekeeping and maintenance:

- the workplace should be kept sufficiently clean;
- where a spillage does occur (and it is a slipping hazard) immediate steps should be taken to deal with it;
- waste materials should not be allowed to accumulate in the workplace except in suitable receptacles;
- the workplace, equipment, devices and systems should be maintained; and
- staircases should have at least one handrail and, where there is a particular risk of falling, two handrails should be provided.

244 Chapter *Health and safety management* gives further information on workplace health and safety requirements.

Managing the risk of slips and trips

245 If slips and trips are to be eliminated or controlled, effective health and safety management is key. Some of these management stages include:

- identifying problem areas;
- deciding what to do;
- putting decisions into practice; and
- checking that any actions have been effective.

246 See chapter *Health and safety management* for more information.

247 Carry out a risk assessment to help identify slip and trip hazards. Paragraphs 248–249 list some of the hazards that should be considered in a risk assessment for slips and trips.

248 Trip hazards include:

- obstructions;
- waste packaging;
- shrink wrapping;
- banded strapping loops;
- holes/cracks and uneven outdoor surfaces;
- pallets;
- changes in surface level – ramps, steps and stairs;
- cables across walking areas;
- loose floorboards/tiles and loose/worn mats/carpets;
- protruding forks from fork-lift trucks;
- bumps, ridges and protruding nails etc;
- low wall and floor fixtures – door catches, door stops; and
- electrical and telephone socket outlets.

249 Slip hazards include:

- waste material – eg shrink/stretch wrap or label backing;
- freezing condensation;
- spills and splashes of liquids and solids;
- wet floors – following cleaning;
- unsuitable footwear;
- loose mats on polished floors;
- rain, sleet and snow;
- change from a wet to a dry surface – footwear still wet;
- unsuitable floor surface/covering;
- dusty floors; and
- sloping surfaces.

250 Factors that increase risk include:

- poor organisation of walkways;
- badly placed mirrors/reflections from glazing;
- poor or unsuitable lighting;
- wrong cleaning regime/materials;
- moving goods/carrying/pushing or pulling a load;
- rushing around; and
- distractions/fatigue.

Preventing trips

251 Trips account for the majority of all reported slip and trip injuries in the storage and warehousing industry. Objects on the floor or uneven surfaces normally cause them.

252 Keep floors and traffic routes free from obstructions that may present a hazard or impede access. This is particularly important on or near stairs, steps, escalators and moving walkways, on emergency routes, in or near doorways or gangways, and in any place where an obstruction is likely to cause an accident, eg near a corner or junction.

253 The following measures will help you manage the risk of trips and related injuries:

- establish a positive culture – trips can be avoided;
- eliminate holes and uneven surfaces in floors inside buildings and work areas outside buildings;
- plan workflows so that goods and equipment do not cause obstructions or project into places where people may walk;
- designate walkways and clearly mark their boundaries. Make sure pipes, electric cables etc do not obstruct walkways;
- provide enough storage, even for busy periods, to prevent goods or other items being stored in walkways and traffic routes;
- plan waste disposal to ensure waste items do not accumulate on the floor or walkways – even small items can present a risk. Good housekeeping is very important;
- materials that fall onto traffic routes should be cleared as soon as possible;
- provide good lighting;
- clearly mark obstacles that cannot be eliminated; and
- ensure that suitable footwear is worn.

254 Regularly inspect the workplace to ensure that there are no trip hazards. Where a hazard is identified it should be rectified promptly, eg flooring that is potholed or uneven due to damage or deterioration should be repaired. Precautions like barriers or obvious markings should be used as a temporary measure to prevent an accident until the repair is carried out.

Preventing slips

255 Slips rarely happen on clean, dry floors. They occur because something gets between the shoe sole and floor and stops them from making good contact, effectively acting like a lubricant. So most slips accidents occur because the floor is wet or contaminated.

256 Within warehouses, water, oil, cleaning products, dry powders and foodstuffs can all contaminate the floor and cause it to become more slippery. Other less obvious items, like polythene stretch wrapping and plastic bags, can also cause slips.

257 There can also be specific slip risks associated with temperature-controlled storage units. See chapter *Temperature-controlled storage* for more information.



Figure 5 Waste disposal

Contamination

258 You should have effective measures to stop the floor getting contaminated in the first place, including:

- checking goods for leaks on arrival;
- having systems for properly reporting and dealing with leaking goods;
- maintaining plant, equipment and the work environment (including the building) and enclosing processes and plant which may discharge or leak liquids (eg by bunding);
- stopping outdoor contaminants getting indoors and onto floors that can become slippery when wet, eg by providing entrance mats to dry wet feet.

259 When contamination does happen it should be dealt with immediately, eg by cleaning.

260 In the winter months, make arrangements to minimise risks from snow and ice. This may involve gritting, snow clearing and closure of some routes, particularly outside walkways, yards or gantries.

Removing contamination

261 Regular cleaning to remove contamination from floors helps reduce slip and trip accidents, but choosing the right cleaning regime is essential.

262 Spillages should be cleaned up immediately. Where possible use dry cleaning methods, such as vacuum cleaners, to remove contamination from the floor. If you use wet cleaning methods, eg mopping, ensure the floor is totally dry before allowing people to walk on it. People often slip on floors that have been left wet after cleaning. On a smooth surface, even a tiny amount of water can be a slip problem. Using a dry mop will reduce the drying time but still leave a slip risk.

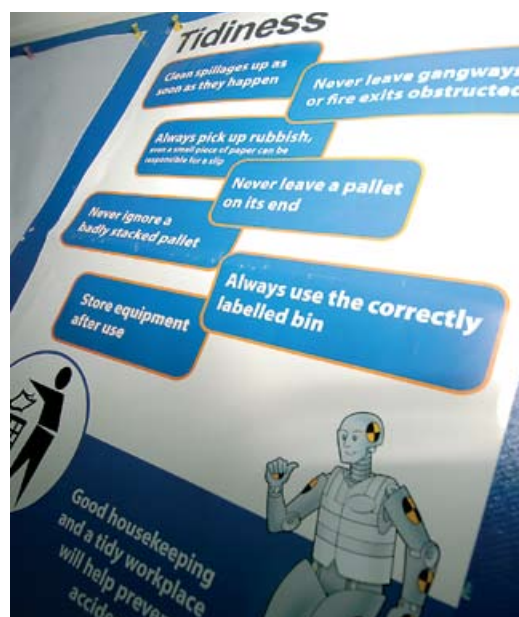

Figure 6 Poster encouraging good housekeeping

263 To keep people out of the wet area, use barriers, clean during quiet times, or clean in sections so there is a dry path through the area. If it is not possible to clean the floor to dry, use barriers or warning signs to keep people off the wet area. However, warning signs and cones do not stop people from walking on a wet floor. If the hazard is not visible, or if they are left out continuously, they will be ignored.

264 Spot cleaning is the best method to use for spillages of non-hazardous liquids as it avoids spreading the contamination or increasing the size of the slip risk area.

265 If a rougher floor is not cleaned properly it may lose its slip resistance, eg wear too quickly, or hold in slippery contamination.

266 It is not just about getting the cleaning technique right; you need to get the schedule right too. Always have staff available to clean up spills when contamination levels are at their worst.

Floors

267 Floors in and around warehouses should not be slippery.

268 Provide effective drainage where a floor is liable to get wet to the extent that the wet can be drained off. Drains and channels should be positioned so as to minimise the area of wet floor, and the floor should slope slightly towards the drain.

269 Where necessary to prevent tripping hazards, drains and channels should have covers that are as near flush as possible with the floor surface.

270 The vast majority of floors have very good slip resistance when they are clean, dry and level. However, smooth floors that become even a tiny bit wet or contaminated will be slippery. So the rougher the floor, the better it will cope with water and other contamination and the less likely someone is to slip.

271 How rough a floor needs to be is closely linked to the type of contamination likely to end up on it; the thicker the contamination the rougher the floor needs to be. Unfortunately, you cannot tell just by touching it if a floor will be rough enough, eg a floor that is rough enough to cope with oils, such as a high performance non-slip vinyl, does not feel very rough to the touch. To find out how much grip a new or existing floor will give, ask your floor supplier for slip resistance information, or undertake measurements of your own.

272 Other points to note are:

- some floors wear rougher over time (eg good quality anti-slip vinyl), some wear smoother;
- if you change a floor when it is fitted, you will alter its slip resistant properties, eg varnishing a wood floor will make the floor very smooth;
- floor treatments, etching and blasting can improve the roughness of certain floors, but they also reduce the life of the floor, can be hazardous to apply and further treatments are usually required.

273 When either laying a new floor or replacing an existing one, you should obtain the right information from the floor manufacturer to enable you to source a product that is suitable for preventing slips.

274 For more information see *Slips and trips: Guidance for employers on identifying hazards and controlling risks* HSG155,²² and *Preventing slips and trips at work* INDG225,²³ and the HSE website for more information on flooring performance.

Stairs

275 Ensure that stairs have adequate handrails and that edges of steps have clearly visible nosings. Non-slip strips on the nosings of steps can be used to reduce the risk of slipping. These should be adequately secured to the nosing.

Footwear

276 The right footwear can help reduce slips. But a shoe that gives good grip on one floor with one type of contamination may not work on a different floor with a different type of contamination. Issuing footwear to control slip risks should only be considered as a last resort; try to eliminate the root of the problem first.

277 In many warehouses, safety footwear is issued to employees to control other risks such as toe injuries. When selecting this type of footwear it is good practice to also consider the slip resistance performance of the shoe.

278 When selecting footwear, remember:

- not all safety footwear is slip-resistant;
- trial different types of footwear before making a final selection;
- correct fit is important; if the wearer's foot moves within the shoe, slips are more likely;
- wearing flat shoes that make good contact with the floor, especially at the heel, can reduce the number of slips;
- the sole pattern should have channels to aid drainage in wet conditions;
- the sole should also be of a design that does not become easily clogged-up with contamination;
- to improve slip resistance in contaminated conditions, the shoe sole should have a well-defined tread pattern;
- a worn heel or worn tread pattern can reduce slip resistance considerably;
- clean shoes regularly to keep the soles free of contamination; and
- think about the sole material. Some combinations of shoe sole and flooring materials have been found to be less slippery than others.

Worker involvement and training

279 Involve employees in analysing the risks and agreeing the control measures, particularly where footwear is concerned. It is especially important that employees are aware of the control measures and that there is adequate supervision to ensure good practice.

280 Provide training for employees, including temporary workers, on the key measures to prevent slip risks such as:

- good housekeeping, including reporting spillages and prompt cleaning up;
- reporting defects in plant and equipment or hazardous conditions; and
- use of suitable footwear and its maintenance.



Figure 7 Anti-slip nosing on steps

Caution: Standard metal profile can become slippery when wet or contaminated

Electrical safety

281 Around 1000 work-related electrical accidents are reported to HSE each year and about 20 people die of their injuries.

282 Touching voltages above approximately 50 volts ac or 120 volts dc can cause electrical injuries such as electric shock and electrical burns, although voltages lower than these can be hazardous in some circumstances, such as in wet environments. The severity of injury generally increases with higher voltages but is dependent upon individual circumstances.

283 Poorly designed, constructed or maintained electrical installations or faulty electrical equipment can also lead to fires that may in turn cause injury and death.

Electricity at Work Regulations 1989

284 The principal requirements of these Regulations are that:

- so far as is reasonably practicable, all electrical systems are constructed at all times to prevent danger. This includes, but is not limited to, the particular requirement that any electrical equipment that may foreseeably be exposed to adverse or hazardous environments (eg wet conditions or the risk of mechanical damage) should be constructed and protected to prevent danger;
- all electrical systems are maintained so as to prevent danger, so far as is reasonably practicable. Maintenance is only required in those circumstances where a failure to maintain may lead to danger;
- precautions during operation and maintenance, including where necessary the adoption of safe systems of work and the competent use of suitable protective equipment, are taken against the risk of death or personal injury from electricity used in the workplace.

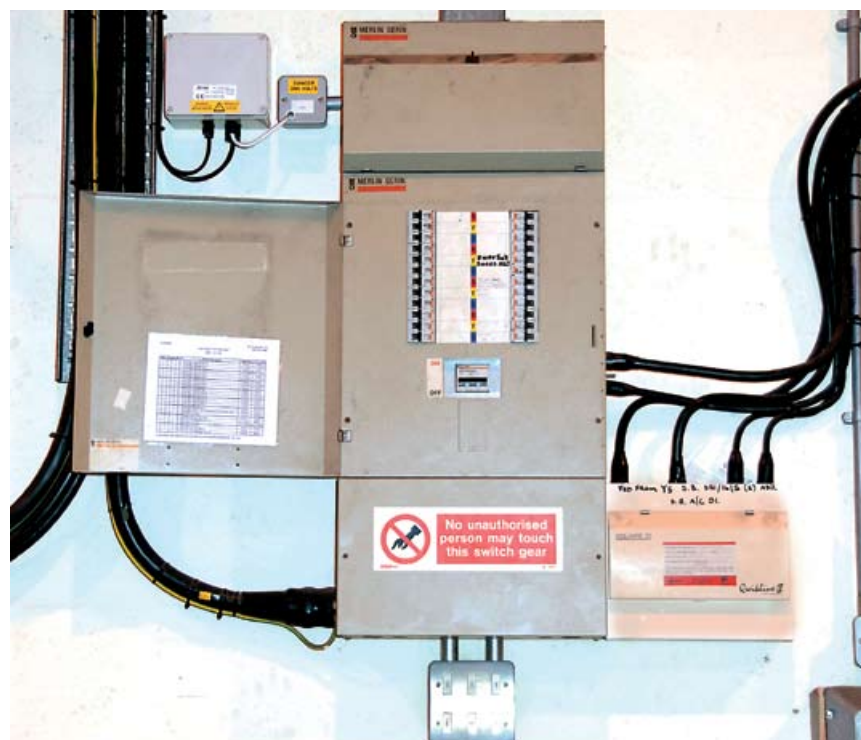

Figure 8 Electrical distribution board with door open to show switch panel

285 Guidance on these Regulations is published in the *Memorandum of guidance on the Electricity at Work Regulations 1989*.²⁴

Fixed electrical installations

286 Fixed electrical power distribution systems should be designed, installed, operated and maintained to a suitable standard. For low-voltage installations of the type typically installed in warehouses, you can achieve this by complying with BS 7671 *Requirements for electrical installations*.

287 Every electrical installation (including alterations to existing systems) must be properly installed by a competent person such as an electrician or electrical engineer. This may mean using external contractors. If so, make sure they are competent to undertake the work. The National Inspection Council for Electrical Installation Contracting (NICEIC) and trade bodies such as the Electrical Contractors' Association (ECA) and the Electrical Contractors Association of Scotland (SELECT) specify the competence requirements for electricians employed by their members and have systems in place for periodically checking their work.

288 Fixed electrical installations need to be maintained in a safe condition. This includes being inspected and tested often enough to ensure that there is little chance of deterioration leading to danger. BS 7671 and its supporting guidance note on *Inspection and testing* recommend the frequencies for the inspection and testing of electrical installations. General warehousing activities with lower risks of deterioration leading to danger should be inspected and tested by a competent person at least every five years, although they should be inspected for signs of deterioration at more frequent intervals. However, there may be higher-risk premises or part of premises that require more frequent inspection and testing. Any part of an installation that has become obviously defective between tests, or has suffered dangerous levels of deterioration, should be de-energised until the fault can be fixed.

289 All electrical switchgear and control gear should be clearly labelled and readily accessible at all times. Goods, pallets etc should not be stored in front of or obstruct access to switchgear or control gear.

290 It is advisable to install residual current protection on supplies to socket outlets, especially if the sockets are likely to supply equipment outdoors, such as power washers, and/or hand-held equipment such as power tools. A residual current device (RCD) with a rated residual operating current not exceeding 30 milliamps (mA) can reduce the likelihood of an electrical injury but under some circumstances a shock can still occur and cause very serious or fatal injuries. Therefore an RCD should only be used as a secondary means of reducing the risk of people being injured by direct contact with electricity.

291 The best place for an RCD is built into the electricity distribution boards to provide permanent protection. If this is not possible, an electrical outlet incorporating an RCD or a plug-in RCD adaptor can also provide additional safety.

292 Regularly test RCDs by pressing the 'test' button to make sure that the RCD trips. If an RCD is faulty or inoperative, remove it from use.

293 Protect light bulbs and other equipment that could easily be damaged in use; there is a risk of electric shock if they are broken.



Figure 9 An RCD in a distribution board

Electrical equipment – generic requirements

294 Electrical equipment supplied from the fixed electrical installation must be safe for use in the prevailing environmental conditions and must be maintained so as to prevent danger. Lasting safety can only be achieved by ongoing and effective maintenance, which can include visual inspection, diagnostic testing, repair and replacement.

295 Electrical equipment is often classified according to its construction; in this context the two most relevant classes are:

- **'Class I' equipment**, which relies on metallic parts being effectively earthed, thereby making it essential for earth connections to be in good condition.
- **'Class II' equipment**, which is double insulated and does not require an earth connection; this type of equipment is marked

296 This classification is important when considering maintenance requirements. A further consideration is whether the equipment is classed as being fixed (eg a palletiser), transportable (eg a welding unit), portable (eg a floor cleaner) or hand-held (eg a drill), as this will affect the maintenance requirements. Cost-effective maintenance of electrical equipment can be achieved by a combination of:

- **user checks**, when the equipment is taken into use and during use. Most electrical faults that lead to danger can be found by the user carrying out a before-use visual check;
- **formal visual inspections** at regular intervals by a person trained and appointed to carry them out; and
- **combined inspection and tests** carried out by an electrically competent person.

297 The correct fuses or circuit breakers should be used in the supply to equipment to ensure that cables are not overloaded.

298 Damaged cables should generally be replaced completely, but if they are to be repaired, this should be by means of a suitable connector (not by using block connectors and insulating tape). Makeshift repairs should never be carried out on cables, eg by using insulating tape.



Figure 10 Isolation switch for fixed equipment

Fixed electrical equipment and machinery

299 Fixed electrical equipment and machinery supplied by a permanent cable must have a means of isolation to allow the supply to be securely disconnected for maintenance work. The isolator should be clearly marked, identifying the equipment or machine it supplies. This isolator should be provided with a means to secure it in the 'off' position.

300 Power cables to machines should be protected against damage, eg by being positioned in a safe location, or by using armoured cable, or by running the cables in conduit or trunking.

301 A suggested initial frequency for the inspection and testing of fixed equipment and machinery is set out in Table 5 for a warehouse and associated office area.

Information technology (IT), transportable, portable and hand-held electrical equipment and appliances

302 Choose work equipment that is suitable for its working environment. Electrical risks can sometimes be eliminated by using air, hydraulic or hand-powered tools. These are especially useful in harsh conditions.

303 IT, movable, portable and hand-held electrical equipment is normally connected to electrical sockets by flexible cables. Many dangerous incidents with this type of equipment are caused by damaged cables or unsafe connections between them and plugs and sockets. Extension cables, plugs and sockets, and cord sets that supply equipment, are classified as portable equipment and are subject to the same requirements as other portable electrical equipment. Extension cables should not be excessively long.

304 Workplaces should have sufficient sockets. Overloading socket outlets by using adapters can cause fires. Having sufficient sockets should also avoid the need for trailing cables. Where a number of pieces of equipment require electrical supplies in the middle of a work area, overhead sockets should be considered. These sockets should be accessible to those who use them.

305 Plugs on electrical cables must be properly connected and the cable secured in the cord grip.

306 The frequency of inspection and testing for this type of equipment should be based on an assessment of risk. Table 6 sets out the suggested initial maintenance intervals.

307 It is recommended that you keep an inventory of electrical equipment, along with maintenance records. You should also have procedures for taking faulty equipment out of use until it is properly repaired.

308 For more information, see *Maintaining portable and transportable electrical equipment* HSG107²⁵ and the Institution of Electrical Engineers' *Code of Practice for In-service Inspection and Testing of Electrical Equipment*.²⁶

Table 5 **Testing frequency for fixed equipment and machinery**

Area	User checks	Class I _____		Class II _____	
		Formal visual inspection	Combined inspection and test	Formal visual inspection	Combined inspection and test
Warehouse	None	None	12 months	None	12 months
Office	None	24 months	48 months	24 months	None

Table 6 Suggested initial frequency of inspection and testing of IT, transportable, portable and hand-held equipment

Area	Type of equipment	User checks	Class I _____		Class II _____	
			Formal visual inspection	Combined inspection and test	Formal visual inspection	Combined inspection and test
Warehouse	IT	Weekly	None	12 months	None	12 months
	Transportable	Before use	1 month	12 months	3 months	12 months
	Portable	Before use	1 month	6 months	3 months	6 months
	Hand-held	Before use	1 month	6 months	3 months	6 months
Office	IT	None	24 months	48 months	24 months	None
	Transportable	Weekly	12 months	24 months	24 months	None
	Portable	Weekly	12 months	24 months	24 months	None
	Hand-held	Before use	6 months	12 months	6 months	None

Specific risks

Wet or damp conditions (pressure washers and steam cleaners)

309 Standard domestic 13-amp square-pin plugs are not suitable for use in wet environments, eg outdoors. Always use plugs and sockets designed specifically for use in wet conditions, with terminals protected against water ingress. See ingress protection (IP) code – BS EN 60529.

310 An RCD rated at no more than 30 mA should always be fitted in the electricity supply to wet or damp locations. This includes supplies to pressure washers and steam cleaners. (See paragraphs 290–292 for more information on RCDs.)

311 Pressure washers should be regularly checked and electrically tested and maintained in accordance with the manufacturer’s instructions for the continued safe operation of the equipment. Where metalwork on the equipment is earthed, testing the earth connection is particularly important to its continued safe operation.

312 If electrical equipment is being used in particularly harsh conditions, it is advisable to select lower voltage equipment, such as 110 volts, supplied from a transformer with its output windings centre tapped to earth.

Explosive atmospheres

313 Where flammable solvents, liquids or flammable gas containers are stored or used, seek specialist advice in relation to the electrical installation and equipment to be installed. You will also require specialist advice where combustible dusts are stored (eg flour).

314 Recently installed equipment should be marked with the ‘Ex’ explosion protection symbol to show it is suitable for use in potentially explosive atmospheres. New equipment being sold in the UK for use in potentially explosive atmospheres must have an explosive atmospheres ‘ATEX’ certificate to indicate that it has been assessed as being suitable for use in specified explosive atmospheres.

Electric vehicle battery charging

315 Paragraphs 432–440 give more information on the charging of vehicle batteries.

Finally

316 If in doubt, ask the advice of a competent person such as an electrician, technician or engineer.



Figure 11 Pressure washer in use



Figure 12 Ex marking showing that the equipment is explosion protected

Accidents and emergencies

317 If things go wrong, workers and members of the public may be exposed to serious and immediate danger. You should consider and plan for accidents and emergencies.

Emergency procedures

318 You should have procedures in place to deal with emergencies such as serious injuries, spills of dangerous substances and fire.

319 The requirement for emergency procedures to be in writing will depend on the scale of your warehousing operation, eg within a small warehouse storing non-hazardous goods, concerns may be limited to a serious injury or a fire. Here the arrangements need only be simple and straightforward, and could include:

- ensuring compliance with fire safety requirements;
- ensuring emergency exits are kept clear at all times;
- clearly marking the premises from the road so that the emergency services can quickly identify the correct site; and
- having the correct first-aid procedures.

320 Within a larger or more hazardous site, you may require formalised arrangements in writing, which should include details on:

- how to raise the alarm in an emergency so that all employees understand that there is an emergency;
- evacuation procedures and muster points;
- displaying a detailed site plan with shut-off valves and electrical isolators clearly marked;
- nominated competent person to take control;
- qualified first aiders; and
- liaison with the emergency services.

321 For more information on emergency procedures where dangerous substances are being stored, see chapter *Storage of packaged dangerous substances*. See paragraphs 165–169 in chapter *Environment and welfare* for more information on fire prevention and precautions.

322 There will be other bodies with a role to play in some incidents, eg the Health Protection Agency, the Environment Agency and the Scottish Environment Protection Agency in Scotland.

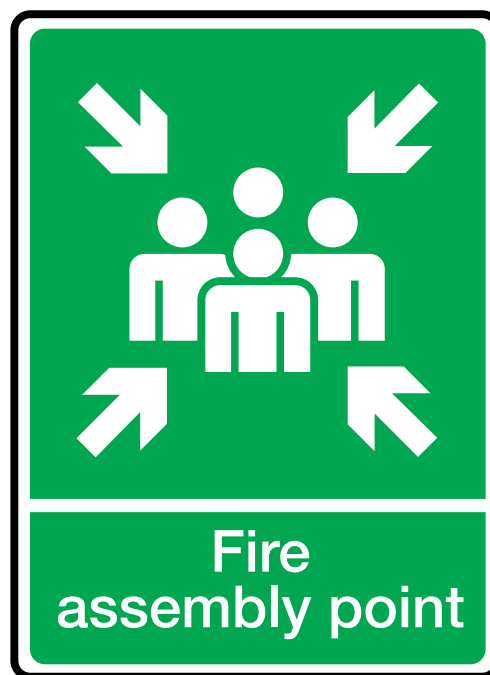

Figure 13 Fire assembly point sign

First aid

323 People working within warehouses can suffer injury or illness. Whether this is caused by work or not, it is important that you have arrangements to ensure employees receive immediate attention if they are injured or taken ill at work.

324 The initial management of injuries and illness, until expert medical attention is received, could make a difference between life and death.

325 The Health and Safety (First Aid) Regulations 1981 set out first aid requirements for the workplace. Employers must carry out an assessment of first-aid needs and ensure that there are:

- adequate and appropriate equipment and facilities for giving first aid to employees. This includes a first-aid box and first-aid room, depending on the size of the warehouse;
- an 'appointed person' where necessary to take charge in an emergency whenever people are at work. The 'appointed person' does not need to be a qualified first aider but should take charge of the first-aid arrangements, including looking after the first-aid box and calling the emergency services when required. Short courses are available for 'appointed persons' covering emergencies, cardiopulmonary resuscitation, the unconscious casualty and the wounded or bleeding;
- qualified first aiders. Whether these are needed and the number required will depend on the nature of the warehouse, the number of employees and location of the site. An appointed person is not necessary when there is an adequate number of first aiders.

326 First aiders should have completed a training course in first aid at work, and hold a valid three-year certificate in first aid at work. After that, a requalification course and re-examination is necessary. Training organisations running first aid at work courses should be approved by HSE.

327 The content of the first-aid box will depend on the type of work carried out and the number of people working at the warehouse.

328 The Approved Code of Practice²⁷ to the Health and Safety (First-Aid) Regulations 1981 gives information on the suggested numbers of first-aid personnel to be available at all times people are at work, along with the contents of a first-aid box. Both should be based on a risk assessment. Table 7 gives a guide to numbers of first aiders required. Most, but not all, warehouses will fall within the medium-risk category.



Figure 14 First-aid and eye wash equipment

329 Where there are special circumstances, such as remoteness from emergency medical services, shiftwork, or sites with several separate buildings, there may need to be more first-aid personnel than set out in Table 7. Increased provision will be necessary to cover for absences.

330 Employees should be informed of the first-aid arrangements. Putting up notices telling staff who and where the first aiders or appointed persons are and where the first-aid box is will usually be sufficient. Where necessary, you should make arrangements to give first-aid information to employees with reading or language difficulties.

331 The Health and Safety (First-Aid) Regulations 1981 do not place a legal obligation on employers to make first-aid provision for people who are not their employees, such as visiting drivers. However, HSE strongly recommends that people who are not your employees are included in a first-aid needs assessment and that provision is made for them.

Table 7 **Suggested numbers of first-aid personnel to be available at all times people are at work, based on assessments of risk and number of workers**

Category of risk	Numbers employed at any location	Suggested number of first-aid personnel
Lower risk, eg shops offices, libraries	Fewer than 50	At least one appointed person
	50 to 100	At least one first aider
	More than 100	One additional first aider for every 100 employed
Medium risk, eg light engineering and assembly work, food processing, warehousing	Fewer than 20	At least one appointed person
	20 to 100	At least one first aider for every 50 employed (or part thereof)
	More than 100	One additional first aider for every 100 employed
Higher risk, eg most construction, chemical manufacture, extensive work with dangerous machinery or sharp instruments	Fewer than 5	At least one appointed person
	5 to 50	At least one first aider
	More than 50	One additional first aider for every 50 employed
	Where there are hazards for which additional first-aid skills are necessary	In addition, at least one first aider trained in the specific emergency action

Reporting injuries, occupational diseases and dangerous occurrences

332 Reporting of injuries, occupational diseases and certain dangerous occurrences are required by the Reporting of Injuries, Diseases and Dangerous Occurrences Regulations 1995 (RIDDOR 95). In particular:

- work-related deaths, 'major injuries' and 'dangerous occurrences' must be reported to HSE or the local authority, by the quickest practicable means (usually telephone);
- work-related deaths, 'major injuries' and all other injuries where someone is unable to do their normal work for more than three days must be reported in writing to HSE or the local authority within ten days of the accident;
- accidents that result in a person not at work (eg a member of the public) suffering an injury out of or in connection with work and being taken to a hospital;

- certain occupational diseases relating to work activities must be reported to HSE or the local authority, when discovered. Some conditions caused by repetitive movements of the upper limbs are reportable diseases that can occur in warehouses;
- those records of reportable injuries, dangerous occurrences and diseases are kept.

333 'Major injuries' include serious fractures, amputations, hospitalisation, etc. 'Dangerous occurrences' include explosion, fire, collapse of a lifting machine, scaffold collapses, etc. The HSE guide to the Regulations²⁸ has full definitions. See also *RIDDOR explained: Reporting of injuries, Diseases and Dangerous Occurrences Regulations 1995* HSE31.²⁹

334 Reporting an injury or occupational disease does not suggest the acceptance of responsibility or liability for the event. It is simply informing the relevant enforcing authority that an incident has occurred. Under RIDDOR 95 it is an offence not to report.

335 There is often confusion about which employer is responsible for reporting an accident that may occur at their site but involves an employee from another employer (eg a visiting driver). The responsibility to report the accident rests with the employer of the injured person. The exceptions to this rule are: if the injured person is self employed or is someone not at work who suffers an injury and is taken to hospital – then the employer in control of the premises where the accident occurred should report the accident. It is recommended that you have a system in place to confirm that:

- accidents at your premises involving other employees have been properly reported by their employer; and
- that accidents to your own employees at other premises are reported by you.

336 Employers must keep a record of any reportable injury, disease or dangerous occurrence for three years after the date on which it happened.

337 RIDDOR reports should be made to:

Incident Contact Centre
Caerphilly Business Park
Caerphilly
CF83 3GG
Telephone: 0845 300 9923
Fax: 0845 300 9924
Website: www.riddor.gov.uk

Investigating accidents and incidents

338 See paragraphs 31–33 for more information on accident and incident investigation.

Materials handling

Manual handling

339 Musculoskeletal disorders (MSDs) are the most common occupational illness in Great Britain. They affect one million people a year and account for more than 40% of RIDDOR-reported 'over-3-day' injuries in warehouses. They include problems such as lower back pain, neck pain and upper-limb disorders. Many work activities can lead to MSDs, from heavy lifting to repetitive order picking.

340 Injuries can occur as the result of a single incident or they can develop over time. A wide range of common work tasks can cause MSDs, and many will be caused by one or a combination of the following risk factors:

- repetitive and heavy lifting;
- bending and twisting;
- repeating an action too frequently;
- uncomfortable working position;
- exerting too much force;
- exerting a force in a static position for extended periods of time;
- working too long without breaks;
- adverse working environment (eg hot, cold); and
- psychosocial factors (eg high workloads, tight deadlines, and lack of control over the work).

341 MSDs are commonly caused, or made worse, by activities at work. The effects of MSDs can be reduced and new cases caused by workplace activities prevented by using a common-sense approach and controlling the risks.

Manual handling risks

342 If there is a risk from a manual handling task, where reasonably practicable the task should be avoided. If this task cannot be avoided, the risk of injury occurring should be minimised as far as is 'reasonably practicable'. Consider all systems of work in the warehouse involving manual handling operations and, where appropriate, redesign tasks to:

- avoid the need to move loads manually; or
- fully utilise mechanical handling devices, eg lift trucks, pallet trucks, trolleys, conveyors, chutes, scissor lifts etc. Where necessary, introduce additional mechanical handling devices to avoid or reduce manual handling.

Manual handling assessment

343 You must carry out a manual handling assessment for all manual handling operations and tasks that present a risk of injury and that cannot be avoided.

344 The assessment should identify where improvements or other measures are necessary to reduce the risk of injury from manual handling operations. Consider the following factors when making such an assessment:

- **The task:** Are there any tasks that involve foreseeable risks? Consider unsatisfactory bodily movements or posture (eg twisting), excessive lifting or lowering distances (eg from floor level to above waist height), excessive pushing or pulling distances, situations where the load is required to be held or manipulated at a distance from the trunk of the body, or repetitive handling.
- **The load:** Are there any loads unsuitable for manual handling? For example, too heavy, bulky, unwieldy, slippery, wet, sharp, unpredictable or unstable.
- **The working environment:** Are there conditions in the warehouse that increase the risk of injury from manual handling operations? For example, constricted work areas, narrow aisles, areas of extreme temperature (hot or cold), over-steep slopes or changes in floor level.
- **Individual capability:** Are there any employees who require specific assessment before undertaking manual handling operations? For example, pregnant women or new mothers, people with known medical conditions, people with previous manual handling injuries or young workers.
- **Other factors:** Is movement or posture hindered by personal protective equipment or clothing? Also consider organisational factors that have an impact on the risk, eg order-picking software.

345 Where the assessment identifies manual handling operations that involve a risk of injury, you should take appropriate measures to reduce those risks as far as is reasonably practicable. These measures could include redesigning the task or system of work, altering shelving heights or the warehouse layout or introducing mechanical handling devices.

346 For more detailed advice see *Getting to grips with manual handling* INDG143,³⁰ *Manual handling: Solutions you can handle* HSG115³¹ and *Manual handling. Manual handling Operations Regulations 1992 (as amended). Guidance on Regulations* L23.³²

347 HSE has developed the Manual Handling Assessment Chart (MAC Tool) to help you quickly identify the risks from lifting, carrying and team manual handling activities. This tool is available free on the MSD section of the HSE website.

Work-related upper-limb disorders

348 Upper-limb disorders (ULDs) are problems with the shoulder and arm, including the forearm, elbow, wrist, hand and fingers, and can include neck pain.

349 In warehouses, ULDs can be caused by a variety of work tasks involving forceful or repetitive activity, or poor posture. The way that the work is organised and managed can cause ULDs as well as make them worse.

350 ULDs fall into two broad categories: those conditions that have a specific medical diagnosis (eg carpal tunnel syndrome, frozen shoulder) and non-specific pain syndromes where it is not possible to define the cause of the pain. The term 'repetitive strain injury' (RSI) is often used, but is not a medical term and is not accurate in describing many ULDs.

351 There is a wide range of ULD symptoms, some examples are tenderness, aches, pain, stiffness, weakness, tingling, cramp, or swelling. Symptoms should never be ignored, even if they appear slight.

352 If there is a risk of ULDs from the work undertaken within your warehouse, you should carry out a risk assessment. The risk of ULDs should be reduced to as low a level as reasonably practicable, eg by changing the way work is organised.

Figure 15 Good handling technique for lifting equipment

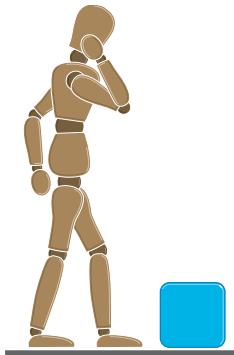

(a) Think before lifting/handling



(b) Adopt a stable position with feet apart and one leg slightly forward to maintain balance



(c) Start in a good posture and get a good hold

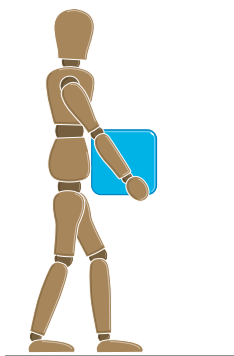

(d) Keep the load close to the waist

353 For more information see *Upper limb disorders in the workplace* HSG60.³³

Managing and controlling the risk of musculoskeletal disorders

354 The risk of all MSDs can be easily managed by following the simple steps in paragraphs 355–361.

Identification

355 Identify which activities are causing a significant risk of MSDs in the workplace. Observe the work being done, discuss with employees and look at injury history. Particular attention should be paid to moving heavy objects, awkward load shapes, strenuous pushing and pulling, stacking above shoulder height, uncomfortable working positions, repetitive work (eg packing) and use of excessive force.

Elimination

356 Tasks identified as presenting a significant risk of causing MSDs should be assessed in more detail to see if they can be avoided altogether, or if the task can be changed to reduce the risk. For example, can the task be automated or significantly assisted by mechanical means?

Preventative measures

357 Where tasks cannot be eliminated or automated, you will need to implement suitable preventive and protective measures to reduce the risk of injury.

Reporting symptoms

358 Encourage your employees to report any symptoms of injury as soon as they notice them. Early reporting of symptoms enables early diagnosis, proper treatment and rehabilitation. In general, back pain can best be tackled by keeping gently active rather than resting. Specialist occupational health advice may be helpful in managing severe episodes of MSDs.

Information and training

359 Employees should be given information about the weight and properties of any load if manually handling the load involves a risk of injury. This is to protect employees, so the information provided should be of practical use in preventing injury. In some cases it may be reasonably practicable to give precise information about the weight, eg by marking this on a load. Where it is not reasonably practicable to do this, general indications about the weight can be provided. If a load has a centre of gravity that is not centrally positioned, then the heaviest side could be marked. This should be done if the load is sufficiently out of balance to take handlers by surprise.

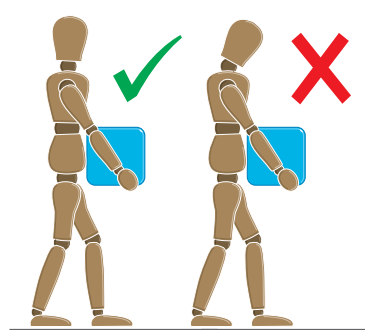

(e) Keep the head up when handling

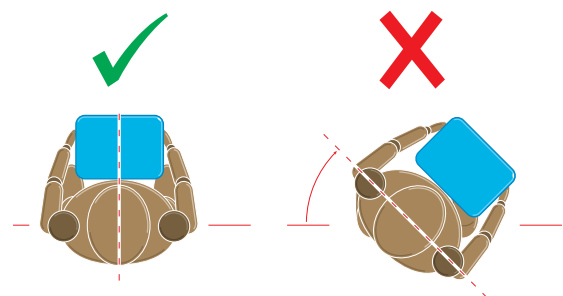

(f) Avoid twisting the back or leaning sideways, especially while the back is bent

360 Ensure that your employees clearly understand how a manual handling operation has been designed to safeguard their health and safety. Training should complement a safe system of work and not be a substitute for it. A training programme should be specific to the tasks being undertaken and should provide a clear understanding of:

- good handling techniques, including posture, lifting techniques and methods of carrying;
- the proper use of handling aids;
- factors affecting individual capability;
- the importance of good housekeeping;
- how potentially hazardous loads may be recognised;
- how to deal with unfamiliar loads;
- the proper use of personal protective equipment; and
- features of the working environment that contribute to safety.

Monitoring

361 Finally, it is important to check that preventative and protective measures have made improvements. You can do this by monitoring sickness absence records and ill health, ensuring there is adequate supervision and monitoring the use of mechanical aids etc.

The supply chain

362 Handling risks are often inherited through the supply chain, eg by the receipt of goods which have not been palletised. If your suppliers and customers can agree on acceptable product weights and maximum pallet heights etc, and how products should be handled, purpose-made handling solutions can be used at each stage.

363 It is also important to ensure that you consider manual handling problems for distribution staff, delivery workers and customers. Each supplier in the chain should co-operate with the others in identifying problems and agreeing solutions.

Roll cages

364 Roll cages (also known as roll containers or roll pallets) are commonly used in warehousing, storage and distribution.

365 When fully loaded, roll cages can generally carry up to 500 kg of goods, but some manufacturers rate the capacity of their containers as high as 700 kg. Roll cages are supplied in a variety of heights, ranging from 1550 mm up to 1830 mm.

366 Musculoskeletal and other injuries arise from:

- pushing/pulling loaded roll cages, especially up slopes, over steps or on uneven floor surfaces;
- trying to prevent roll cages overbalancing (and crush injuries where this was not successful);
- repetitive loading and unloading of roll cages;
- trapping hands while assembling/dismantling cages;
- trapping hands and other parts of the body between the roll cage and a wall, side of vehicle etc;
- feet being trapped under the castors; and
- roll cages falling off lorries (eg from the tail lift) during loading and unloading, often causing the most serious injuries.

Designs to reduce injuries

367 The most important design features that will help reduce roll cage incidents are:

- the use of large-diameter wheels, to reduce pushing/pulling forces and to make these less sensitive to surface imperfections (eg the forces required to overcome a small step are typically 12–24% greater if using a 100 mm diameter wheel, as opposed to a 125 mm diameter wheel);
- the careful selection of wheel material – hard materials such as nylon will lower rolling resistance and, unlike cast iron, should not damage floors or make too much noise, although polyurethane wheels are quieter and produce less vibration on rough surfaces;
- good quality castors, each with a well-maintained wheel bearing (ball bearings offer the least rolling resistance, followed by roller bearings and then plain bearings, as used on nylon wheels, although the latter require less maintenance);
- castors close to corners to improve stability;
- incorporating handles (at a height of approximately 1000 mm) to move fingers away from the corners of containers where they are vulnerable to impact and, when cages are pulled, to keep feet further from the castors;
- marked load height limits, to enable the operator to have a clear view when pushing the load.

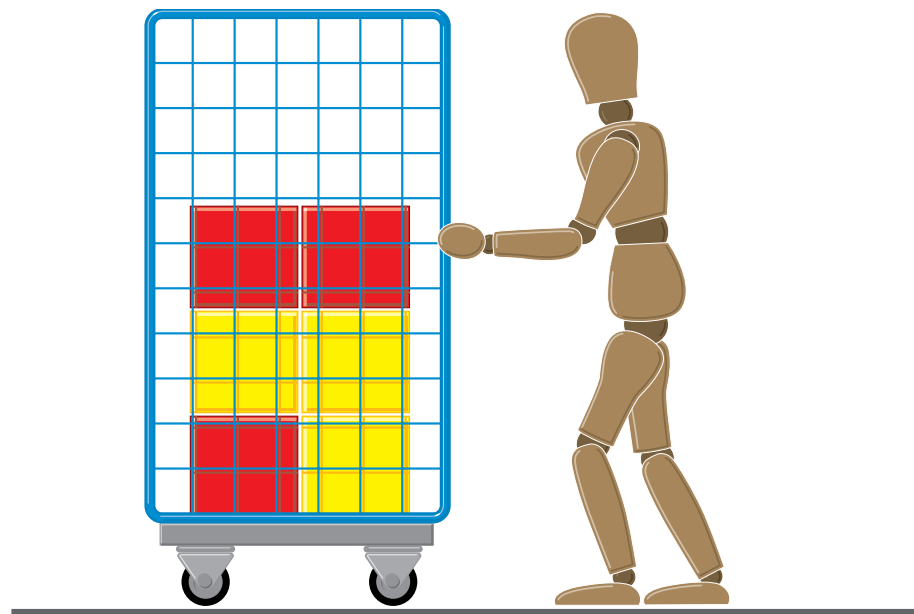

Figure 16 Roll cage

Risk assessment for roll cages

368 Carry out a risk assessment for each roll cage application, covering both on-site and off-site risks including:

- pushing/pulling options;
- forces required to move the roll cage;
- the effect of slopes and terrain/floor surface problems;
- availability of safe handles;
- visibility for the operator;
- hand/body/foot trapping risks;
- slips and trips;
- correct lifting methods for loading and unloading the roll cage; and
- risks associated with loading/unloading roll cages onto lorries (eg with tail lifts).

369 Pushing roll cages (rather than pulling) is the preferred option, although in practice, both pushing and pulling are necessary in most situations. Pushing has ergonomic advantages (two hands can be used and there is less twisting). There is also less risk of foot trapping or impact injury if the cage overruns or the operator slips. There is more information on pushing and pulling, along with assessment templates, in *Manual handling. Manual Handling Operations Regulations 1992 (as amended). Guidance on Regulations L23*.³²

370 When considering pushing/pulling forces, the risk assessment should take into account the sex and weight of the person pushing the roll cage. Female workers can typically exert only 60% of the force of male workers. Older and very young workers (male and female) may also have reduced capabilities.

371 For pushing/pulling on slopes, your risk assessment should be particularly cautious. For example, a roll container with a load of 400 kg and a slope of 1 in 12 (4.8°) would require a force of 33 kg (330 N), well above the force a man might be expected to handle and double the force a woman might be expected to handle. Slips are also more likely on slopes, especially with the extra pushing forces required.

372 With uneven surfaces, the maximum starting force could rise to 10% of the load. Moving heavily loaded roll containers is therefore likely to place lone operators at risk of injury, even on level surfaces.

Safe working with roll cages

373 Your employees should be trained in the use of roll cages and the safe system of work. The following precautions have been shown to reduce injuries. Operators should:

- only move one roll cage at a time;
- use the handles provided;
- move the roll cage no faster than walking speed;
- wherever possible, push the cage rather than pull, as this is ergonomically better and will reduce the risk of foot trapping;
- seek help from another person when moving a roll cage up or down a ramp or on an uneven surface or when a cage is heavily loaded;
- not ride in or on roll cages, as they can easily overturn or trap the operator;
- wear gloves and safety shoes when moving roll cages – softer sole shoes will reduce slips;
- wear gloves to protect hands and fingers when assembling cages;
- stack heavier items at the bottom of the roll cage to keep the centre of gravity as low as possible (the correct lifting technique is particularly important at this low level);
- not overload the trolley;
- not load the cage above the load line or above the level where the operator can see over the load;
- move no more than three to five empty, nested roll cages at one time (see manufacturer's recommendations).

Inspection and maintenance of roll cages

374 Poor maintenance can be a factor in accidents involving roll cages, for example, jammed or faulty wheels or protruding sharp edges.

375 You should have systems in place for the inspection and maintenance of roll cages.

Trolleys

376 Where your workers use trolleys, select a suitable design. Trolleys are designed to be used on level, even surfaces. If used on a gradient there may be a risk of trolleys freewheeling out of control and causing injury to people. Trolleys should not be used on gradients unless a safe system of work is adopted to prevent such risks from occurring.

377 Carry out a manual handling assessment for the use of trolleys.

378 Make sure you have systems in place for the inspection and maintenance of trolleys.

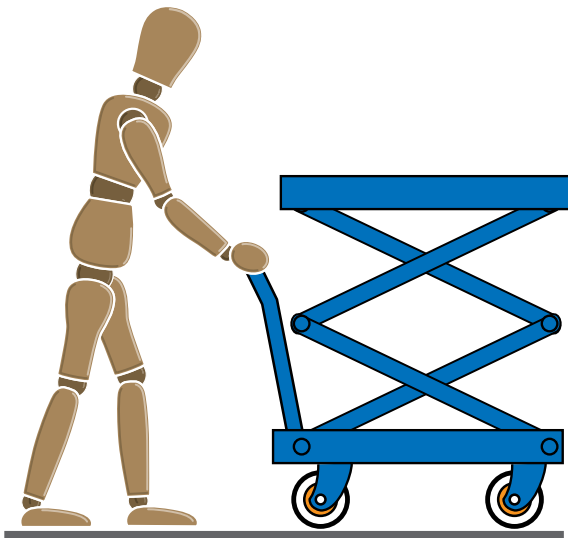

(a) Platform truck

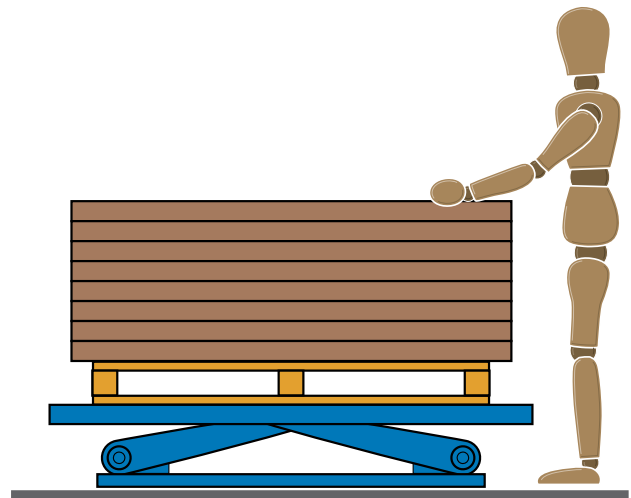

(b) Adjustable height turntable

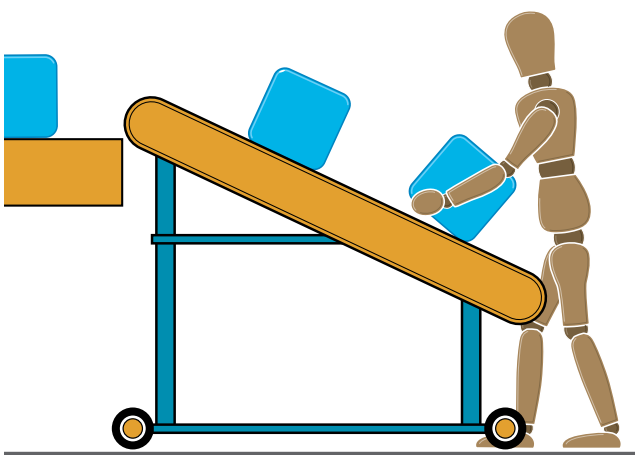

(c) Mobile conveyor

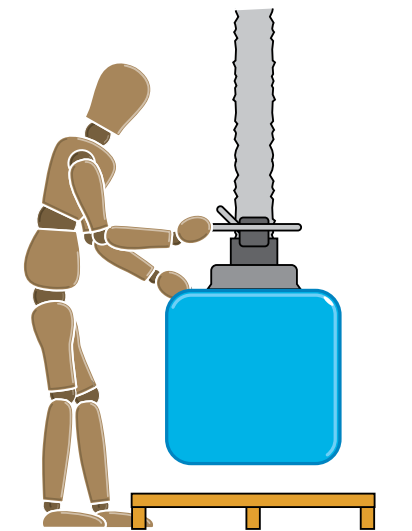

(d) Vacuum hoist

Figure 17 Lifting and handling aids

Mechanical handling

379 This chapter gives information on the type of machinery which may typically be employed for the movement of stock within warehousing, its safe use, training requirements in respect of the operators, and employers'/employees' responsibilities and obligations.

Industrial trucks

380 Industrial trucks include lift trucks and vehicles such as tow tractors. Together they account for a large proportion of accidents in warehouses. Many of these accidents are due to operator error associated with inadequate or lack of training. There are, however, other reasons for truck accidents, including unsuitable premises, poor layout and design of truck operating areas and poor truck maintenance. Employers using trucks should therefore adopt safe systems of work, eg for training employees, procedures for traffic and pedestrian movement, and for control and maintenance of trucks.

381 Employers should also have arrangements for the selection and procurement of lift trucks and their attachments to ensure that health and safety requirements, such as visibility, access, ergonomic operation and maintenance, are included and given an appropriate priority.

382 Table 8 lists the common types of trucks used in warehousing. This list is by no means exhaustive. It indicates the inspection regime with the maximum interval for periodic inspection. All the trucks listed require inspection under the Provision and Use of Work Equipment Regulations 1998 (PUWER), and most also need thorough examination under the Lifting Operations and Lifting Equipment Regulations 1998 (LOLER) (see paragraphs 424–428).

CE marking

383 All trucks supplied between 1 January 1989 and December 1995 must display an 'E' mark. From January 1996, trucks must display a 'CE' mark to show that they comply with the relevant EC Directives.



Figure 18 Counterbalanced fork-lift truck

Table 8 Inspection regime for common types of trucks

Type	Figure number in Appendix 3	Operator positions	Thorough examination/ periodic inspection requirement	Maximum inspection interval ³
Counterbalanced fork-lift truck up to 5 tonne	1	Rider or pedestrian	LOLER and POWER	12 months
High-lift platform trucks	2	Rider	LOLER and POWER	6 months
Pallet stackers	3	Stand on or pedestrian	LOLER and POWER	12 months
Straddle trucks	4	Stand on or pedestrian	LOLER and POWER	12 months
Reach trucks	5	Rider, stand on or pedestrian	LOLER and POWER	12 months
Medium-lift order picking trucks (up to 2.5 m lift)	6	Rider	LOLER and POWER	6 months
High-lift order picking trucks	7	Rider	LOLER and POWER	6 months
Very narrow aisle lateral and front stacking trucks – man-up	8	Rider	LOLER and POWER	6 months
Very narrow aisle lateral and front stacking trucks – man-down	9	Rider	LOLER and POWER	12 months
Pivot steer trucks	10	Rider	LOLER and POWER	12 months
Bi- and multi-directional fork trucks	11	Rider	LOLER and POWER	12 months
Pallet, stillage, low-lift ¹ platform and low-lift order picking ² trucks	12	Rider, stand on or pedestrian	POWER	Follow manufacturers' guidance, which will usually be 12-monthly intervals. ⁴
Pedestrian powered/ controlled pallet truck	13	Pedestrian	POWER	
Tow tractor	14	Rider	POWER	

Notes

- ¹ 'Low lift' is defined as lifting just sufficient to permit horizontal travel; or
- ² in the case of low-lift order pickers, up to an operator platform height of 900 mm.
- ³ These are the maximum periods between thorough examinations under LOLER, and are the defaults in the absence of an examination scheme. If an examination scheme has been produced then the period may be different.
- ⁴ Inspection frequency should be based on how quickly the equipment or parts of it are likely to deteriorate; this decision should be made by someone with the correct skills and experience.

Marking and rating plates

384 Paragraphs 385–387 apply to all trucks.

385 Trucks should be marked legibly and indelibly (eg weather-proof profiled letters) with the following minimum details:

- name and address of the manufacturer or the authorised representative;
- designation of series or type;
- serial number and the year of manufacture;
- unladen mass of the truck in working order without removable attachments and battery for battery-powered trucks, but with fork arms or integral attachments. The mass may vary from the figure shown by up to $\pm 5\%$;
- rated capacity.

386 Additional details, as required depending on truck type (eg mast trucks):

- actual capacity at maximum lift height with load centre distance;
- actual capacities at other lift heights and load centre distances if applicable;
- actual capacity with each removable attachment fitted at the manufacturer's authorised lift height(s) and load centre(s);
- on battery powered trucks, the authorised maximum and minimum battery mass and the system voltage;
- the nominal power in kilowatts (kW).

387 Other information may include:

- locations for slinging;
- for pneumatic-tyred trucks, the inflation pressure; and
- filling points for fuel and hydraulic oil.

Safety requirements

388 All powered industrial trucks should be fitted with:

- a device to prevent unauthorised use, such as a switch with a removable key, or a keypad with PIN number;
- a clearly audible warning device (horn); and
- an overhead guard (on ride-on trucks that lift over 1800 mm).

389 The following additional safety measures may also be necessary:

- a load backrest, if the truck is used to move small objects liable to fall on the operator;
- lights, if the truck is used in drive-in or drive-through racking, or in other poorly lit areas;
- a flashing warning beacon and/or automatic reverse warning device. Trucks designed to elevate the operator more than 3000 mm above floor level should be fitted with a flashing warning beacon. The warning device should flash and be visible from ground level. The warning device should flash when the operator position is being lowered and when the truck is travelling.

Operator restraint

390 All ride-on centre-seated counterbalanced trucks (group B) must be fitted with an operator restraint such as a lap-type seat belt.

391 Operator restraint should be worn at all times when lift trucks are in motion unless, subject to risk assessment:

- the lift truck operator needs to dismount repeatedly and frequently (eg to position loads on the forks or check stock levels);
- the truck is used on a smooth, firm, level surface (eg concrete floor); or
- the truck is unlikely to be operated at speeds or in ways that could cause overturn due to the nature of the operations being carried out and the area in which it is working.

392 Operator restraint always needs to be worn in areas where the lift truck can be turned at speeds approaching maximum speed or on gradients and terrain that can lead to overturning at lower speeds.

393 Where wearing a restraint is not required throughout a site, you will need to have measures in place to indicate where lift truck operators should wear their restraint. Signs may be displayed in the lift truck or at appropriate access points to the areas where operator restraint should be worn. Also, operators should be instructed and supervised on the wearing of seat restraints.

394 Further information can be found in *Fitting and use of restraining systems on lift trucks* MISC241.³⁴

Attachments

395 The risk of loads falling from the truck can be reduced by the use of suitable attachments, eg fork extensions or barrel clamps. In all cases, consult the manufacturer or the authorised dealer of the truck about the suitability of the attachment for a particular truck. The attachment should be suitable for the task, eg unclamped heavy loads should not be carried resting under gravity on a clamped load item below; this practice has led to fatal accidents.

396 Fitting an attachment, such as a clamp and including a side shift, will affect the capacity of the truck. Reducing the truck capacity to account for the effect of fitting an attachment is called de-rating. De-rating should be carried out by the truck manufacturer or an authorised dealer. The truck, when fitted with an attachment, must have a rating plate specifying the capacity of the truck when fitted with that attachment. Note that the capacity that may be marked on the attachment is not always the same as that of the combined capacity of the truck with the attachment.

397 Truck operators will require additional training on the use of such attachments.

Working platforms on lift trucks

398 Work at height is a high-risk activity, the planning and selection of work equipment and safe means of access and egress and working area is important. There is a variety of equipment now available for work at height, such as mobile elevating work platforms.

399 The primary function of a lift truck, with the exception of man-up trucks (such as order pickers) is the carriage, raising and lowering of materials not people. The Work at Height Regulations 2005 place a duty on employers to select the most suitable work equipment for the task and integrated working platforms offer a higher degree of safety than non-integrated platforms.

400 There are restrictions on the circumstances in which non-integrated working platforms (ie those without operating controls in the platform) can be used on lift trucks.

401 The use of lift trucks with non-integrated work platforms is only permitted for occasional use (eg tasks such as clearing a blocked gutter) that would otherwise be carried out using a less safe means of access such as ladders, where it is impractical to hire in purpose-designed lifting equipment due to the short duration of the task.

402 Routine or planned tasks, particularly those associated with production or pre-planned activities such as periodic maintenance or stocktaking, are not exceptional circumstances and are not examples of occasional use. Consequently, fork-lift trucks fitted with non-integrated working platforms are not suitable for order picking, routine maintenance or the transfer of goods or people from one level to another.

403 Lift trucks that are used to lift people in working platforms require more frequent LOLER inspections. Paragraph 424 gives more information.

404 The requirements for working platforms on fork-lift trucks are detailed in *Working platforms (non-integrated) on fork-lift trucks* PM28.³⁵



Figure 19 A fork-lift truck with push-pull attachment

Protecting pedestrians

405 The mixture of industrial trucks and pedestrians is a recipe for potential accidents, so it is imperative that you take steps to minimise the associated risks:

- separate pedestrian activities from areas where trucks are operating, where reasonably practicable. This is particularly important in retail warehouses where the public may be present;
- define, designate and clearly mark pedestrian routes and crossing places;
- provide sufficient clear and unambiguous warning signs at strategic locations to inform people that trucks operate in the premises or area;
- provide suitable and sufficient notices at strategic locations and instruct truck operators to sound the horn.

Members of the public

406 The public should not be permitted in industrial truck operating areas. Where members of the public visit warehouse premises, they should be accompanied and should wear appropriate PPE, ie high-visibility coats, protective footwear etc. This should be in accordance with the requirements of the Personal Protective Equipment Regulations 2002. If a lift truck needs to enter an area when the public has access, such as during normal opening hours (eg a retail warehouse), there should be a written procedure outlining precautions to be taken. These should include barricading off the area where the lift truck is operating and giving loudspeaker announcements to warn shoppers.

Employees and visiting drivers

407 Wherever possible, restrict access to lift truck operating areas to those staff who operate truck equipment or have a supervisory role. The same general precautions as listed above for members of the public may be appropriate to protect employees who do not normally have to enter truck operating areas.

408 Where employees work in conjunction with trucks, additional precautions should be adopted:

- Write out the safe system of work. Drivers should not operate if a pedestrian is in their immediate area. Employees should be instructed to stand clear of trucks that are lifting or lowering loads and to use separate walkways where provided. People should be reminded of the dangers of entering areas such as those behind the truck where they may not be fully visible to the driver and also that the tail-swing, particularly on counterbalanced trucks, is very pronounced.
- Consider fitting flashing warning beacons to trucks.
- The use of reverse audible warning on lift trucks may be beneficial in some applications but you need to assess the effects of background noise, nuisance levels, and confusion on direction or source, particularly if more than one vehicle is being used in the area.
- Site-specific control measures are particularly important in racking aisles.

409 See chapter *Vehicles in and around the warehouse*, particularly paragraphs 507–508.

Industrial truck operating areas

410 All industrial truck operating areas should be suitably designed and properly maintained. When designing the layout of these areas, consider the following:

- Driving areas should be as flat as possible and free from obstructions. Features of the building or operating area, eg support columns, pipework or other plant, should be identified, protected and clearly marked by black and yellow diagonal stripes. The edges of loading bays should be clearly marked in a similar way.
- Roads, gangways and aisles should have sufficient width and overhead clearance for the largest industrial truck using them to do so safely, whether loaded or unloaded, and if necessary, to allow other vehicles and loads to pass each other in safety. If vertical deflection traffic calming features (speed bumps) are used to reduce the speed of other traffic, provide a bypass for use by industrial trucks. Consider using one-way traffic systems to reduce the risk of collisions.
- Buildings, rooms, doorways, and traffic routes should be clearly marked to avoid unnecessary traffic movements.
- Avoid sharp bends, blind spots, and overhead obstructions where possible. Visibility aids should be considered when vision is restricted.
- Display notices instructing industrial truck operators to sound horns at appropriate locations. All warning signs should conform to the Health and Safety (Safety Signs and Signals) Regulations 1996.
- Arrange lighting to avoid glare (eg flexible doors of transparent or translucent material will reflect like a mirror if it is appreciably darker on one side of the door than on the other) and sudden changes of lighting levels, eg where industrial trucks may pass from bright sunlight into the building.
- Provide sufficient parking areas for all industrial trucks. Parking areas should be away from the main thoroughfare and work areas. Wherever possible, provide suitable parking areas for recharging or maintenance. For refuelling, further considerations are necessary – see paragraphs 429–431.
- Minimise slopes and gradients and ensure that there are no cross-gradients.

411 In areas where industrial trucks are to operate, the floor should be of the appropriate flatness as specified by the truck supplier. This is particularly relevant in very narrow aisle (defined movement) applications where inappropriate floor conditions can lead to reduced operating speed, potential damage to load and racking and discomfort for the operator.

412 Carry out periodic inspections of the floor. Encourage your employees to report any significant defects. Criteria for defects, such as subsidence, unevenness, holes, collection of surface water, cracks and ruts, should be determined and set, and maintenance systems developed to undertake repair when these limits are exceeded. Also consider the tripping hazard to pedestrians.

Controlling the use of industrial trucks

413 You should have a system in place to ensure that industrial trucks are only used by authorised operators.

414 Keep keys, where used, in a secure place when the industrial truck is not in use. They should be issued by a responsible person and retained by the operator(s) until the end of the work period. At no time should the truck be left unattended with the keys in the ignition or the keypad energised. At the end of the shift, a truck should be parked safely and the keys returned to the responsible person or the keypad de-energised.

415 On LPG trucks, the gas supply should be turned off at the storage tank if the truck is to be left for any period of time.

416 Further advice on the safe operation of industrial trucks can be found in *Safety in working with lift trucks* HSG6.³⁶

Maintenance and examination of industrial trucks

417 Employers should have:

- a planned routine maintenance system;
- a system for reporting defects and for ensuring that remedial work is carried out;
- a documented pre-shift check; and
- thorough examination/safety inspection.

418 Follow the manufacturer's instructions on inspection, maintenance and servicing. The operator, unless suitably qualified and authorised, should not carry out repairs and adjustments to the truck. If a truck is hired, make arrangements to ensure proper inspection, maintenance and servicing. (In some cases, the hire company may undertake regular inspection, maintenance and servicing as part of the hire contract.) You should keep a written record of maintenance and examinations (see paragraph 425).

Pre-shift check

419 At the beginning of each shift, all trucks should be checked and results documented by the operator in accordance with the manufacturer's operator's manual.

420 A typical pre-shift check will include the following:

- condition of wheels and tyres, and security of wheel nuts;
- parking and service brakes operate efficiently;
- audible warning, eg the horn;
- lights and mirrors;
- fluid levels, eg fuel, water, lubricating oil and hydraulic oil levels are correct in internal combustion engine industrial trucks;
- where appropriate, industrial truck batteries are adequately charged;
- systems for lifting, tilting and manipulation are working properly;
- damage; and
- any obvious signs of hydraulic leaks.

421 The Fork Lift Truck Association publication *Operator safety – Daily checks*³⁷ provides useful blank checklists.

Defect reports

422 In the event of breakdown or a defect being identified, this should be reported immediately to the supervisor through a defect reporting system. Where the defect is a safety critical item, (eg brakes, steering) the truck should be withdrawn from service until rectified. You should have a system in place to prevent future use of the truck until the fault is rectified. You should retain reports until the next thorough examination.

Checklist 3: **Monitoring safe operation of industrial trucks**

Working practices should be monitored by a responsible supervisor to ensure that safe systems of work are followed. This list is a basic guide – it is not exhaustive and is not intended to be a substitute for the guidance and training available from industrial truck manufacturers and training bodies.

Operators should **never**:

- lift loads that exceed the truck's rated capacity;
- travel with a bulky load obscuring vision;
- travel on soft ground unless the industrial truck is suitable for this purpose;
- carry passengers;
- block firefighting equipment or exits by parking or stacking in front of them;
- attempt to carry out repairs – leave this to a qualified maintenance engineer;
- use attachments unless:
 - de-rating (ie reducing the rated capacity of the industrial truck) has been carried out by a competent and authorised dealer or manufacturer;
 - operators have been properly trained and are competent and authorised to use the truck with the attachment;
 - the attachment is used in accordance with the manufacturer's instructions;
- allow people to walk under raised forks or load;
- travel with a raised load, unless the truck is designed for this purpose; or
- attempt to turn on an incline.

Remember:

- never allow unauthorised people to operate the industrial truck.

Operators should **always**:

- observe floor loading limits – find out the weight of the laden truck;
- watch out for obstructions;
- ensure the load is not wider than the width of the gangways;
- watch out for pedestrians and bystanders;
- travel at speed suitable for the environment;
- wear operator restraints, where fitted (see paragraph 390–394);
- when driving on inclines, ensure that:
 - when carrying the load, it faces uphill;
 - when no load is carried, the fork arms face downhill;
 - where fitted, the tilt is adjusted to suit the gradient and the fork arms are raised to provide ground clearance; and
 - turning or stacking is avoided;
- avoid sudden stops;
- slow down for corners and sound the horn where appropriate;
- travel with fork arms lowered while maintaining ground clearance;
- ensure bridge plates are secure and strong enough to withstand the weight of the truck and the load;
- carry out a pre-shift check of the industrial truck (see paragraph 419–421);
- lower loads as soon as they are clear of the racking;
- lower loads at a safe speed;
- leave the truck with the fork arms fully lowered;
- switch off and remove the key when leaving the truck; and
- take note of the load capacity indicator when fitted.

Planned routine maintenance and inspection

423 There is a requirement under PUWER for all work equipment to be regularly maintained in accordance with the manufacturer's recommendations. In addition to changing oils and filters, and any mechanical adjustments, this will normally include inspection of all safety related components. The frequency of maintenance is usually based on hours run, but once equipment is in service and working to a set routine, this can often be converted into a schedule based on a service interval of weeks or months.

Thorough examination

424 A 'thorough examination' is similar to the MOT inspection for a car or lorry, which is in addition to regular servicing. Lifting parts of industrial trucks, such as the mast, chains, carriage, forks and tilt mechanism, also need to be thoroughly

examined by a competent person. This must be done at least every 12 months, or in accordance with an examination scheme. Equipment that is used to lift personnel, even on an occasional basis, or attachments not permanently fitted to a specific truck must be thoroughly examined at least every six months, or in accordance with an examination scheme. Thorough examinations should be carried out by a 'competent person'. A 'report of thorough examination' will be issued by the competent person and must be retained by the employer for at least two years.

425 If the competent person considers that there is a defect indicating an existing or imminent risk of serious personal injury to the operator or others, they should indicate this on the report of thorough examination and recommend to a person in authority that the equipment should be withdrawn from service immediately. The competent person is required to copy any report made under these circumstances to the appropriate enforcing authority.

426 Lifting equipment that does not require a thorough examination under LOLER, such as a hand pallet truck, should have a safety inspection at least every 12 months. You should retain the inspection report for at least 12 months.

427 Further guidance is given in the British Industrial Truck Association guidance note GN28 *Thorough examination and safety inspections of industrial lift trucks*.³⁸

428 Table 8 gives more information on the application of PUWER and LOLER to industrial trucks.

Refuelling industrial trucks

429 Areas used for refuelling industrial trucks with diesel, LPG or petrol should be outside and the risk of fire and explosion should be considered. Refuelling should not take place where there is a likelihood of an accumulation of flammable vapours in the event of a spillage, eg drains, pits, gulleys etc. Smoking should be prohibited and notices should be clearly displayed in these areas and engines should be switched off before refuelling.

430 The Petroleum Licensing Authority can advise on the standards necessary to comply with the Petroleum (Consolidation) Act 1928 as amended by the Dangerous Substances and Explosive Atmospheres Regulations 2002 (DSEAR).

431 The cylinders of LPG-fuelled lift trucks should be changed outside the warehouse away from all possible sources of ignition.

Charging batteries – electrically powered industrial trucks

432 Charging batteries, including those that are described as maintenance free, gives off explosive hydrogen gas. If this is allowed to collect and a source of ignition (naked flame or spark) is present, then the gas and battery will explode.

433 Battery charging should therefore take place in a well-ventilated area where smoking, naked flames or other ignition sources are prohibited. Designate a separate room or area for charging batteries.

434 Charging rooms or areas should have good ventilation located at high level immediately above the batteries; where a large number of batteries are being charged in a confined area, forced ventilation should be considered. Seek further advice from the battery manufacturer.

435 Keep electrical apparatus and any other potential sources of ignition well to one side and/or sited below the level of the battery, but not in a position where any spillage of electrolyte could fall onto the electrical apparatus.

436 The area should be designated 'No smoking' and 'No naked lights'.

437 To avoid sparks, the charger should be switched off before the battery is connected to or disconnected from it.

438 Where batteries have to be changed, eg in a double shift system, a safe system of work should be in place. The person responsible for changing the batteries should have suitable training and instruction on how the change is to be carried out safely. Battery acid also presents a hazard to skin and eyes.

439 Charging should not be carried out in cold stores due to low levels of ventilation or hazardous areas.

440 When charging vehicle batteries:

- always use the correct charging unit as specified by the vehicle/battery manufacturer and follow manufacturer's instructions;
- ensure all electrical circuits are switched off before connecting/disconnecting batteries;
- raise the battery cover to aid ventilation during charging; and
- wear the correct PPE where required (eg acid-proof apron, gloves and goggles or a visor).



Figure 20 Battery charging station

Use of industrial trucks where flammable materials may be present

441 There are two main hazards associated with the use of lift trucks in flammable atmospheres:

- direct ignition of the surrounding flammable atmosphere (eg by hot surfaces, unprotected electrical equipment or hot sparks from the exhaust);
- ingestion of a flammable atmosphere into the engine air intake. If this happens, the engine is liable to accelerate out of control causing over-speeding, and possible flashback through the intake to ignite the surrounding flammable atmosphere.

442 For these reasons, lift trucks should not be used in areas where flammable vapour, gases or dusts are liable to be present, unless they have been suitably designed and equipped for such use.

443 Diesel-fuelled trucks may be used, providing certain precautions are being taken. Petrol and LPG-fuelled trucks should not be used because they cannot, as yet, be protected for such use. If there is any doubt about the suitability of a lift truck for use in such circumstances get competent advice, from the manufacturer.

Training truck operators

444 The Approved Code of Practice (ACOP) *Rider-operated lift trucks. Operator training* L117³⁹ gives practical advice to help employers ensure that **all** operators, even those who use lift trucks on an occasional basis, receive adequate training. It is the duty of employers under the Health and Safety at Work etc Act 1974 to ensure that all operators they employ, both new and existing, are adequately trained and competent.

445 The ACOP does not apply to 'stand-on' pallet trucks that do not lift materials for stacking. However, these trucks are capable of causing major injury and all operators should be adequately trained. Although not directly applicable, *Safety in working with lift trucks* HSG6³⁶ and the ACOP can provide some useful information to help with training for this type of equipment.

446 No person should be permitted to operate a lift truck unless properly trained, competent and authorised in writing by the employer to do so. The authorisation should only be given for the type or types of truck for which training has been successfully completed.

447 Take care when selecting potential truck operators. Operators should be:

- reliable;
- able to do the job;
- responsible in their attitude;
- physically capable – this should be on an individual basis. Reasonable adjustments should be considered to meet the needs of operators; and
- adequately supervised if under 18, unless they have the necessary competence and maturity.

448 The list in paragraph 447 applies to all applicants, including people with disabilities. However, 'reasonable adjustments' may be required to enable some disabled people to work as lift truck operators.

449 Operator training should be carried out by a competent person and always include the three stages of training:

- **basic training:** the basic skills and knowledge required for safe operation;
- **specific job training:** knowledge of the workplace, operating principles and controls of the lift truck to be used, and experience of any special site rules, systems of work and specific handling attachments; and
- **familiarisation training:** operation on the job under close supervision.

450 The first two stages may be combined or integrated but should always be off-the-job. You should keep a record for each employee who has satisfactorily completed any stage of lift truck training. This should include sufficient information to identify the employee, the nature of the training completed and copies of any certificate of training.

451 Trained and experienced lift truck operators need to be reassessed from time to time to ensure that they continue to operate trucks safely. Operators should be reassessed at the frequency (typically three to five years) laid down in your monitoring procedure.



Figure 21 Very narrow aisle man-up truck

452 You should also consider reassessment where operators:

- have not used a truck for some time or are occasional users;
- appear to have developed unsafe working practices;
- have had an accident or near miss; or
- have undergone a change in their working practices or environment.

Checking qualifications

453 When employing lift truck operators who already possess a training certificate, it would be prudent to check that the organisation that carried out the training is accredited by one of the bodies recognised by the Health and Safety Commission (HSC). These are:

- the Association of Industrial Truck Trainers (AITT);
- the Construction Industry Training Board (CITB);
- the Independent Training Standards Scheme and Register (ITSSAR);
- Lantra National Training Organisation Ltd;
- the National Plant Operators Registration Scheme;
- RTITB Ltd.

454 Further information can be found in the Approved Code of Practice (ACOP) and guidance *Rider-operated lift trucks. Operator training* L117.³⁹

455 All newly appointed lift truck operators will need specific job training – covering knowledge of the workplace and experience of any special needs and handling attachments.

456 Lift truck operators with training certificates from outside the UK will have to be assessed; this could be done by them attending refresher training in the UK.

457 If the training provider is not accredited, you will need to make further checks and carry out an assessment to ensure competence.

Instructor competence

458 You should have a system in place to check the competence and suitability of instructors. For example, if they are an ‘outside’ training provider, some things to check would include:

- the trainer’s accreditation (if they are not accredited, they should be asked how they meet the standards set out in the ACOP);
- the body they are accredited by;
- their last monitoring visit or date of retraining; and
- documentation such as:
 - a certificate of training (instructor qualification);
 - an insurance certificate (public liability at least); and
 - proof they can train on the vehicles in question.

Training facilities

459 Consider the training facilities:

- Is the area off-the-job suitable?
- Is the machine to be used freely available?
- Is the classroom suitable?
- Is the machine fit for the purpose?

Needs of the employer

460 The training provided should cover the range of operation and use of the lift truck.

Supervisor training

461 The training of lift truck operator supervisors should include an appreciation of all the training measures which are necessary to ensure the safe use of trucks within the workplace. The relevant managers should have an appreciation of the risks and of the methods of minimising those risks in the working environment. Training courses are available for supervisors who have no experience of lift truck operation but who supervise lift truck operators.

Medium/high-lift man-up (elevating operator) machines

462 These are machines that elevate the operator to a height of 1200 mm or greater above ground level. They may be order picking or very narrow aisle (VNA) lateral front-stacking trucks. They are generally used in narrow or VNA applications.

Modes of operation

463 There are various modes of operation for these types of machines including:

- free-ranging: steered by the operator at all times and not normally intended for use within aisles that are less than at least 300 mm clearance either side of the truck width;
- rail-guided: operated within very narrow aisles but can range freely in open areas. Rollers on the sides of the truck engage with guide rails normally floor mounted within the aisles;
- wire-guided: guided by an electronic guidance system while in a very narrow aisle by a signal generated from a wire buried in the warehouse floor, and steered by the operator when in other areas.

464 Travelling speed will normally be automatically controlled depending on lift height and whether in or out of aisle.

Special safety requirements and training

465 Special requirements and training are needed when medium/high-lift order pickers and man-up VNA lateral and front-stacking trucks are used:

- the notice on the platform should also indicate the maximum number of people permitted on the operator's platform when in use;
- to prevent the operator getting trapped between the truck and racking/load, provide means to keep the operator within the confines of the operating position while operating the truck, eg two-handed control. Any additional person should be similarly protected;
- trucks designed to elevate the operator more than 3000 mm above ground level should be fitted with an emergency lowering control, operable from floor level, whose function is to return the elevating operator position to floor level. Suitable training should be given on the procedures to be adopted in the use of this emergency device;
- where the operator elevating mechanism employs chains, fit a device(s) that will detect when there is no tension in a chain and it goes slack. When a slack chain is detected, the downward motion of the operating position elevating mechanism will be stopped automatically;
- provide information on the procedure to be followed should the operator be blocked in an elevated position. A device such as a klaxon may be used to attract attention. If an escape harness and equipment is provided, it should be inspected regularly and specific and regular training on its use should be given by a qualified instructor.

Low-level order pickers used for second-level picking

466 Second-level order picking is common within the storage and warehousing industry and low-level order-picking trucks with elevating operator positions can be used for this type of work. CE-marked trucks designed for this purpose should satisfy the relevant European Standards (EN 1726, Parts 1 and 2). These standards do not require fall protection where the working platform cannot elevate more than 1200 mm above ground level.

467 For low-level order pickers with a step-up facility onto the top of the battery compartment for occasional second-level picking, handholds should be provided.

Use of fork-lift trucks on the road

468 If a fork-lift truck is to be used on the road it must be registered with the Driver and Vehicle Licensing Agency (DVLA). The Road Traffic Act 1988 defines a 'road'; in relation to England and Wales this means any highway and any other road to which the public has access, and includes bridges over which a road passes.

469 A significant factor affecting the duty to be paid is whether the truck will travel beyond the immediate vicinity or a distance of over 914 m (1000 yards) of the premises in which it usually operates. If the truck is used for distances of less than 914 m then it may be described as a 'works truck', ie it is designed for use in private premises and is used on public roads for:

- carrying goods between private premises and a vehicle on the road in the immediate vicinity;
- passing between one part of the premises and another, or to other private premises in the immediate vicinity;
- use with road works at or in the immediate vicinity.

470 When a vehicle is a 'works truck' it must still be registered and the appropriate duty paid. The exception is electrically propelled trucks, which are exempt from licence fees, but must still display a valid tax disc with 'null' amount entered.

471 Number plates should be fitted while the vehicle is in use on the public road. The form of plate should comply with current requirements.

472 The requirements relating to the lighting of all vehicles used on the public road are contained in the Road Vehicles Lighting Regulations. These regulations generally apply, but lights are not required if the vehicle is not used on the roads in darkness. If lighting equipment is fitted, however, it should be in working order at all times.



Figure 22 Roller conveyor

473 Amber rotating or flashing lights should be carried by vehicles that cannot exceed 25 mph where they are used on dual carriageways with a speed limit of over 50 mph. This is not likely to apply to a fork-lift truck used for loading in the close vicinity of the factory. An amber flashing light may have been fitted for site purposes, but this is optional.

474 The licensing of fork-lift trucks and payment of relevant tax is dealt with by the DVLA. Enforcement issues relating to licensing of fork-lift trucks and drivers, payment of relevant road tax and lighting of vehicles on the road are dealt with by the police.

475 Consider the suitability of the truck for the condition of the road surface.

Conveyors

476 There are many types of conveyor system but the two most commonly found in warehouses are belt conveyors and roller conveyors:

- Belt conveyors comprise a moving belt, driven by a drum (head pulley) at one end, passing over a free-running drum (tail pulley) at the other end, the upper portion of the belt being supported by free-running idler rollers or suitable flat surfaces. This type of conveyor can be arranged for horizontal or inclined travel, the angle of slope depending on the goods conveyed and the type of belt surface.
- Roller conveyors comprise a series of moving steel rollers, either free running or power driven. They can be arranged for horizontal or inclined travel.

477 The main hazards associated with belt and/or roller conveyors are:

- drawing-in, trapping or entanglement hazard with transmission machinery, eg rotating shafts, couplings, chains etc;
- drawing-in hazards between the belt and head and tail pulleys;
- drawing-in hazard at the transfer point between a belt conveyor and a roller conveyor or a fixed surface;
- drawing-in hazards between the belt and return idler rollers or tensioning rollers;
- drawing-in hazard between powered rollers and non-powered rollers of a roller conveyor;
- shearing and impact hazard between the load being carried and a fixed structure; and
- drawing-in and shearing hazard between the load being carried and rollers.

478 You should adopt the following safeguards when such conveyor systems are used:

- Head and tail pulleys, all transmission machinery and drawing-in hazards between belt and idler rollers should be suitably guarded (to PD 5302:2005 and BS EN 619(b)) at the transfer point between a belt conveyor and roller conveyor providing 'jump-out' rollers (ie those that are designed as to be free to 'jump-out' should an object or part of someone's body come between the roller and moving belt).
- Power-driven roller conveyors should have the following:
 - all rollers should be power driven;
 - where powered and non-powered rollers are present, nip guards should be provided between rollers;
 - each non-powered roller should be of a 'jump-out' type.

- Suitable emergency stop arrangements should be provided in accordance with BS EN 418:1992, eg emergency stop buttons strategically located, or a trip wire along the length of the conveyor. Emergency stop arrangements should be designed so that manual resetting by an authorised person is necessary.
- A safe system of work should be established for long or complex conveyor systems to ensure that people are not exposed to any unnecessary risks, eg when a conveyor system is set in motion at the start of a working period or after an emergency stop has been used.
- Where overhead conveyor systems are used, screening or other suitable arrangements should be provided to protect people from falling objects, in accordance with BS EN 953:1998.
- Riding on conveyor systems should be strictly prohibited.

Mobile vehicle loaders/conveyors

479 A typical operation of a mobile vehicle loader or conveyor is the loading and unloading of vehicles to and from a mezzanine floor level.

480 Periodic checks should be made to ensure all fixing bolts remain tight. This is particularly relevant to the mounting bolts on the castors, which are prone to harsh treatment and vibration in normal use.

481 The power supply lead should be checked daily for wear and tear or any sign of damage.

Checklist 4: **Safety hints for mobile vehicle loaders/conveyors**

When the loader is not in use, always:

- apply the footbrakes to all castors;
- ensure that the electrical power is disconnected; and
- ensure the tongue is fully retracted and supported by its chassis.

When moving the loader, always:

- ensure that the electrical power is disconnected;
- fully release all brakes;
- take care when moving the unit over any uneven surface and never attempt to push the unit onto a pavement or up and down slopes; and
- ensure that nobody walks below the conveyor booms.

When loader is in use, always:

- apply all footbrakes; and
- keep clear of the moving belt.

Never attempt to ride on the belt.

Never attempt to walk below conveyor booms.

Do not lean over the moving belt. While every effort has been taken in the design of the equipment to minimise pinch points and finger traps, leaning over a moving belt can present the risk of clothing or long hair being caught.

When loading:

- load goods centrally on the belt;
- avoid overloading the belt; and
- do not convey goods which are obviously too large and bulky and are likely to fall off.

482 Employees using the equipment should be trained in its use. You should also provide appropriate manual handling training – paragraphs 359–360 give further information.

Musculoskeletal disorders and conveyers

483 Where goods or stock are placed onto or recovered from conveyers, the risk of musculoskeletal disorders should be considered (see paragraph 342). There is useful information on the HSE website on the ergonomic considerations for designing and selecting conveyor belt systems.

Scissor lifts

484 Scissor lifts can be used in the storage and warehousing industries, eg to offload wheeled containers. They can be fixed in place or mobile. Hazards pertinent to both types include:

- trapping and/or crushing, either in the parts of the scissor mechanism or under the descending lift;
- falls from the lift platform when elevated;
- electrical integrity; and
- excessive loading.

485 Mobile lifts require a suitable moving device ('tug'), and demand a significant force to be exerted dependent upon the ground conditions, but are a more flexible option for some circumstances.

486 Control measures can include:

- only permit trained persons to operate the equipment (normally the warehouse staff);
- report faults immediately and take the equipment out of use until certified as safe to use;
- carry out regular safety checks, including visual inspection of safety interlocks on gates, and the operation of safety bars and emergency stop device;
- planned preventive maintenance and a scheme of thorough examination every six or 12 months, dependent on whether the equipment is used for lifting people or not;
- suitable means of isolating the lift during maintenance and chocking it to prevent it descending while being worked on;
- interlocked gates, so they must be closed before the lift is moved;
- safety signs displayed immediately adjacent to or on the equipment, indicating rules for safe operation and the safe working load;
- the appropriate safety bar, chain or doors are kept closed and the lift in the down position when the lift is not being used;
- wire meshing or skirts to prevent litter accumulations and to guard the scissor mechanisms. Keep all packaging, equipment and other debris/boxes etc clear of the lift;
- in addition, for mobile lifts: locking wheels and an assessment of the manual handling implications of moving it.

Mechanical handling of waste materials

487 Some warehouses have equipment for handling waste materials, eg compactors and balers. This kind of machinery can present a risk of life-threatening and major injuries, eg from crushing or amputation.

488 There is information on the HSE website about the minimum safety standards for the design, construction and use of compactors and bailers. Operators of this kind of machinery should familiarise themselves with this guidance.

Overhead travelling cranes

489 Overhead travelling cranes are found in certain specialised storage warehouses, eg metal stockholders. The hazards and safety requirements for such equipment are complex and beyond the scope of this publication.

Vehicles in and around the warehouse

490 The chapter *Mechanical handling* deals with matters relating to industrial trucks such as fork-lifts. This chapter relates to all vehicles moving within a warehouse and its surrounding site. It does not cover work-related road safety, which is dealt with in the leaflet *Driving at work* INDG382.⁴⁰ Further information relating to vehicles in the workplace is available in *Workplace transport safety: An employers' guide* HSG136.⁴¹

491 Vehicle movement in the workplace requires careful and constant management to control and reduce the likelihood of accidents. Simple steps can often prove effective, because many of the problems that result in accidents are very straightforward.

492 You need to make sure that your site itself, the vehicles (including mobile equipment) being used, and the people working with and around this equipment, are all effectively managed to properly control transport risks. There is a *Site inspection – Workplace transport checklist* on the HSE website which may be useful.

Managing deliveries and visitors

493 Planning and communication are at the heart of transport safety. People associated with vehicles are often visiting warehouses for a relatively short time and are often employed by other companies (like suppliers, hauliers or agencies), or can be customers or their employees. An employer has a legal duty to make sure that people are safe in the workplace they control, even where they are employed by others or are members of the public. Employers are also responsible for making sure that their employees' safety is being protected on other premises.

494 Vehicle loading and unloading activities should form part of the risk assessment undertaken by both the employer in control of the premises and the employer of any visiting drivers. All of the employers involved in the delivery and collection of goods, whether they own and control the site, provide employees to manage the site or have employees visiting the site, should exchange any relevant information on health and safety that relates to these activities.



Figure 23 Visiting drivers reporting at gatehouse

495 It is important that people coming to the site are given the information they need to ensure their own safety and that of others in plenty of time. You should make sure that visiting drivers know what to expect when they arrive at the site and are made aware of any restrictions on vehicle size or type. It is also useful to highlight any hazards on routes approaching your premises (such as low bridges) so that they can plan for a safe journey. Where it is reasonable, provide maps, directions, safety instructions and information about who to report to, where, and when (including the time vehicles should arrive on site), and so on, before the driver leaves to visit the site, even for one-off visits.

496 Consider how you will communicate with visiting drivers who do not speak and/or only have a limited vocabulary or understanding of English. Many companies have site rules, illustrated with pictograms, prepared to cover expected foreign languages.

497 When lorry drivers arrive on site, it should be clear what their responsibilities are and who is in charge of their activity on the site. Usually, a driver will be responsible for everything relating to the movement of their vehicle, and site workers are responsible for everything that happens while the vehicle is stationary, like loading and unloading. It is important that site workers and visiting employees are able to communicate effectively, using agreed signals where verbal communication is not possible. It should always be clear who is in charge and you should have arrangements for handing over control between visiting and site workers. In particular, where barriers to communication, like dock seals, are in place, alternative means of effective communication should be used.

498 All visitors should be carefully managed while on your premises. They should be given clear instructions on site rules, which should include the use of PPE where necessary.

499 All visitors should be given basic guidance on what steps to take in case of an incident or accident and should have a responsible person to monitor them. A good test is to ask yourself: if you were a visitor or driver coming onto your premises, would you be satisfied with the way you were managed?

500 The risk of accidents happening can be greater at certain times. Risk assessments should take account of periods where the number of vehicles or pedestrians moving along traffic routes change, eg when office staff arrive or leave, or when shifts change. Put in place suitable measures to control these risks, eg stopping lorry movements during shift changes.



Figure 24 Giving information to visitors

Pedestrian safety

501 Every workplace should be organised so that pedestrians and vehicles can circulate safely. Workplace traffic routes should be suitable for the people and vehicles using them. Where vehicles and pedestrians use the same traffic route, there should be adequate separation between them.

502 You can achieve separation by keeping pedestrians and vehicles well clear of one another, ideally using completely different routes. If routes must be close to each other (eg side by side), physical barriers to prevent pedestrians or vehicles straying into each other's areas should be put in place where this is reasonably practicable. Control measures could include:

- pedestrian- or vehicle-only areas;
- separate areas for car parking away from lorry and lift truck operation;
- clear pedestrian walkways;
- barriers and kerbs;
- crossing points;
- separate pedestrian doors at vehicle access/egress into buildings;
- traffic light controls;
- increased lighting, and hence visibility;
- wearing of high-visibility clothing;
- 'no pedestrian access' areas during loading and unloading operations;
- 'no unauthorised access' areas (visitors and contractors); and
- clear control of drivers once they have left vehicles (walkways, safe zones etc).

503 Within the warehousing site, complete separation of vehicles and pedestrians should be the first consideration. Where complete separation is not reasonably practicable, other control measures need to be implemented. For example, it is not always possible to fully separate pedestrians and industrial trucks within warehouses.

504 Paragraphs 405–409 give more information on pedestrian safety where industrial trucks are being used.

505 When you are considering risks to pedestrians, do not forget vehicles that may be moving slowly, eg when reversing or manoeuvring. Even at low speeds, vehicles can cause death and injury. Consider separation first for slow vehicles and pedestrians. Pedestrians should also be reminded that:

- vehicles remain dangerous even when moving slowly;
- site vehicles can move in a different way to cars, eg rear-wheel steer fork-lift trucks, tow trucks, articulated lorries;
- pedestrians should stop until they are sure that the vehicle driver has seen them.

506 Some employers find it useful to identify all the reasons why pedestrians may need or want to walk into vehicle areas, and then remove the need for pedestrian access where possible.

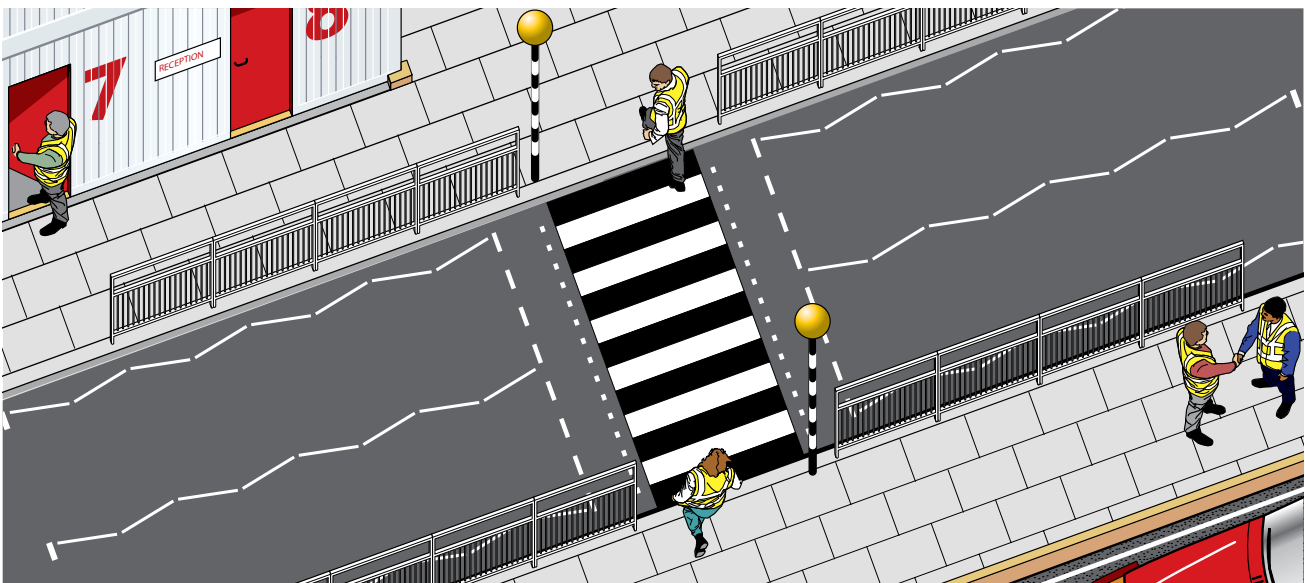

Figure 25 Zebra pedestrian crossing

Protecting pedestrians working with vehicles

507 The following safeguards should be made where pedestrians are working with or adjacent to vehicles:

- members of the public and non-essential employees, eg office staff, should not be permitted into areas where vehicles are moving or being loaded/unloaded;
- provide sufficient clear warning signs to show that vehicles operate in the area;
- instruct all employees and visiting drivers to stand clear when vehicles are moving or being loaded by lift trucks, cranes etc;
- provide employees with adequate PPE for their work, such as safety footwear and high-visibility clothing.

508 Lorry drivers may need to observe the loading or unloading operation. If this is essential, provide a safe viewing area away from vehicle movement and give lorry drivers clear instructions as to where they should observe. Fork-lift trucks should not be in the vicinity if the lorry driver is attending to his vehicle or load. If drivers are not required during loading/unloading, they should be instructed to use a reception or waiting area (where provided) or wait in the cab (unless there is a risk from doing so).



Figure 26 Pedestrian/vehicle segregation

Traffic routes

509 When designing traffic routes, remember:

- vehicle routes should be wide enough for the largest vehicle liable to use them;
- the need for vehicles to reverse should be minimised as far as possible, eg by using one-way systems and drive-through loading areas;
- sharp bends and blind corners should be avoided. Where they are unavoidable, effective warning signs and suitably placed mirrors may help to reduce danger;
- traffic routes should be made of a suitable material and should be constructed soundly enough to safely bear the loads that will pass over them;
- road surfaces should be properly maintained and potholes should not be allowed to develop;
- any slopes should not be so steep that they pose a risk to the safety of work that takes place on them, including the stability of vehicles or their loads.

Managing transport

510 To effectively control the risks from workplace transport, it is important that you address such issues as pedestrian segregation, speed controls etc, and put in place active monitoring by supervisors and managers to ensure that your own employees and visiting employees are complying with these safety measures. This should include how you will deal with individuals who may not be complying with your standards as well as trying to identify the underlying causes that result in non-compliance. For visiting employees, it is recommended that you address non-compliance with the individual and discuss the issue with their manager to address the underlying causes.

Traffic signs

511 Provide sufficient clear road and direction signs, giving a clear indication of right of way, and which part of a route vehicles should use. Signs on traffic routes in the workplace should be the same as those used in the Highway Code. These are defined in the Traffic Signs Regulations and General Directions 2002.



Figure 27 Traffic signs

Lighting

512 All areas in the workplace where vehicles and people move should be sufficiently lit – see Tables 1 and 2 in chapter *Environment and welfare*.

Parking

513 Parking areas should be firm, level, well drained, and constructed of a suitable material. Parking, especially for private cars, should be away from the main traffic flow. You should have procedures in place to make sure that both vehicles and trailers are securely braked, and chocked and stabilised where appropriate. Vehicles and trailers should only be left on a surface suitable to support the full weight of the vehicle/trailer and any load etc.

Coupling and uncoupling

514 Every year fatal accidents occur as a result of unsafe coupling and uncoupling. The parking brakes on the tractor unit and the semi-trailer of an articulated combination should always be used. You should have procedures in place to check that coupling and uncoupling of trailers happens safely and that semi-trailers are parked with the parking brake correctly applied. More information is available in the Code of Practice *Coupling or uncoupling and parking of large goods vehicle trailers*.⁴²

515 Only competent staff should be involved in the coupling and uncoupling of drawbar trailers and parking brakes must be applied correctly, without reliance on stored energy.

Stability of semi-trailers

516 Semi-trailers need support at the front end when they are uncoupled from the tractor unit. This is usually provided by a pair of 'landing legs', which are lowered or raised manually. The distribution of the load changes as loading or unloading progresses. Some trailers may approach the point where they become unbalanced about the landing legs or front-heavy if the load is not evenly distributed. This may cause the trailer to 'nose-dive' or cause the landing legs to collapse; this should be covered by risk assessment. Control measures should include effective planning of load distribution and training the loading operators to ensure they are aware of the risk. A safety jack or other suitable support may be necessary for some loads.

Reversing vehicles

517 Reversing vehicles cause a significant number of fatal transport accidents each year where people are struck by vehicles in the workplace.

518 Plan your site to reduce the risks from reversing vehicles:

- remove the need to reverse altogether. Set up one-way systems or drive-through loading/unloading positions;
- where this is not possible, designated reversing areas where pedestrians are prohibited can be effective;
- in any case, separating pedestrians from vehicles is essential if accidents are to be avoided (eg by setting out clear and safe pedestrian walkways);
- if the site is small, the size of vehicle visiting may need to be restricted to allow safe access and minimise the need for reversing.

519 If it is not possible to change the site layout then other control measures will be necessary.

Vehicle-based reversing aids

520 Vehicle-based aids can be helpful if vehicles are delivering to sites where reversing cannot be eliminated or where it will not be possible to guarantee pedestrian segregation, eg public places.

521 Vision aids such as closed-circuit television (CCTV) can be used to improve drivers' rearward visibility. CCTV allows drivers to detect people at the rear of the vehicle before or during reversing. Companies who have fitted CCTV to their vehicles and trained drivers to use it properly have reported tangible benefits, not only in cutting the risk of injuries, but also in reducing impact damage to vehicles and property. However, they should only be used in conjunction with other reversing aids, such as mirrors, and will need regular maintenance and cleaning to be effective.



Figure 28 Reversing sensor

522 Vehicle-based sensing systems, such as ultrasonics, are also available. Companies have found these of most use as parking aids, not for detecting pedestrians, as they have only limited range and slow speed of operation. They can be effective in combination with CCTV.

523 The use of banksmen (signallers) to control reversing operations is not a preferred option and should be subject to a full risk assessment, as it can involve putting the banksmen in the potential danger area of a reversing vehicle. Every year banksmen suffer serious and fatal injuries while at work. If you have to use banksmen, make sure they are trained to carry out their duties safely. There should be a safe system of work that ensures the banksmen and driver are using standard signals – see the Health and Safety (Safety Signs and Signals) Regulations 1996. The driver should be instructed to stop the vehicle immediately if the banksmen disappears from view.

524 Pedestrian marshals can be used to keep pedestrians away from an area where a vehicle is reversing. Make sure that there are systems in place to ensure the safety of pedestrian marshals, who should be kept clear from the vehicle itself.

Load safety

525 Remember:

- No vehicle should be loaded beyond its rated capacity or beyond the legal limit of gross weight for that vehicle.
- Before loading is started, check the vehicle floor to ensure it is clear of loose objects, in good condition and safe to load.
- Loads should be properly secured or arranged so that they are safe for both transportation and unloading, eg so that they do not slide forward in the event of sudden braking, or move sideways when cornering.
- Carry out loading/unloading so as to maintain, as far as possible, a uniform distribution of the load.
- Have in place a system to check for and to safely deal with any loads that may have shifted in transit.
- Before loosening any load-bearing ropes or straps etc, check the vehicle and load to ensure that doing so will not allow materials or goods to fall.
- Loading and unloading vehicles from one side using lift trucks can result in pallets on the opposite side being disturbed sufficiently to cause a pallet(s) to fall. The opposite curtain or side should be retained in position while loading/unloading.
- The driver is responsible for ensuring the load is secure and should give instructions on positioning of loads to lift truck drivers.
- Where the driver has not been involved in loading and the vehicle/trailer body is secured, the driver should be given a written assurance that the loading and security have been carried out in a proper manner (eg a signed statement on the loading sheet).
- Loading should not take place on significant gradients.

526 Detailed information is given in the Department for Transport (DfT) publication *Safety of loads on vehicles*.⁴³



Figure 29(a) Loading bay with arrow highlighting bay numbering



Figure 29(b) The writing on this additional sign has been reversed so it reads correctly when viewed by a driver in their rear-view mirror

Reducing the risk of people falling

527 Employers have a legal duty to manage the risk of falls and should avoid the need for people to work at height where this is reasonably practicable.

528 When goods or materials are being unloaded from one level to another and there is a risk of injury from a fall, fall protection measures should be taken. Measures that prevent people falling (eg barriers) should be taken first, then measures that protect a person from falling (eg work restraint). If prevention is not possible, other measures should be taken. Marking edges is the last resort to deal with residual risks, as it does not prevent or mitigate the effects of a fall and is of no use when a person has their back to the edge.

529 Falls from vehicles in the workplace are the cause of about a third of workplace transport major injuries. You should consider the following, especially when purchasing new vehicles:

- remove the need for people to go up on vehicles where possible, eg locate gauges and controls where they are accessible from ground level;
- walkways should be of slip-resistant grating or similar;
- guard rails may be needed for work at height;
- where people have to climb up to or onto a vehicle or trailer, the vehicle or trailer should be provided with a well-constructed means of access that should where necessary include appropriate handhold(s);
- as a last resort, where operations do have to happen at height and permanent safe access on the vehicle is not possible, an alternative means of access should be provided (eg by suitable fixed ladders and platforms or stepladders) at the site by the site operator or owner.

Dock levellers

530 Dock levellers are devices used to bridge the gap between the loading dock and vehicle trailer.

531 The main hazards associated with dock levellers are:

- trapping of feet or toes between the descending platform and loading dock;
- overturning of mechanical handling devices;
- trips or falls of people, goods or materials; and
- trapping of people underneath the dock leveller.

532 The following safeguards should be used:

- When a dock leveller integral to a loading dock is not in use, the platform should be returned to a horizontal position flush with the loading dock as soon as loading/unloading is completed. A mechanism fitted to the dock leveller that automatically returns the platform to a horizontal position after use will give increased protection against the risks caused by the platform being left inadvertently raised or depressed.
- Toe guards should be provided, eg fencing at the sides of the leveller that prevents feet or toes from being caught under the platform as it descends.
- Provide skirts, plates or other suitable devices to enclose the trapping hazards below the platform.
- Provide a mechanism that prevents the platform from falling in the event of an emergency, eg a driveway.
- Provide manually operated scotches or other equally effective means to enable the dock leveller to be mechanically locked in a raised position when maintenance or repair work is necessary.



Figure 30 Dock leveller in use

533 Defective safety features, twisted, cracked or misaligned platforms or other defects with dock levellers can cause serious accidents. You should have a planned routine maintenance system, as well as an effective system to report defects and carry out remedial repair work.

Tail lifts

534 Tail lifts are lifting platforms fitted to a vehicle. The main hazards are:

- people falling from the platform (eg while manoeuvring loads from the vehicle onto the tail lift);
- people being struck by loads falling from the platform (eg wheeled delivery cages);
- trapping feet or toes between the moving platform and the ground or stationary parts of the vehicle;
- trapping fingers or parts of the body in moving mechanisms; and
- trapping people under the platform.

535 Tail lifts must be constructed and installed to appropriate standards – BS EN 1756 Parts 1 and 2.

536 Further information for manufacturers, specifiers and users can be found in *Tail lift specification guide for road vehicles*⁴⁴ SOE/IRTE.



Figure 31 Vehicle with tail lift

537 Tail lift safeguards include:

- 'hold-to-run' controls, which return automatically to 'off' when released. All controls should be designed to prevent accidental operation, clearly marked to indicate the direction of movement, and positioned so that the operator has a clear view of the platform throughout its travel;
- elimination of finger and toe traps. Where minimum safety gaps cannot be provided (eg on some types of cantilever lift) tripping devices are an alternative;
- providing grab rails and guard rails where there is risk of a fall from height;
- the safe working load should be clearly marked and never exceeded;
- proper maintenance and lubrication should be carried out in accordance with the manufacturer's instructions;
- vehicles should never be driven with a loaded tail lift platform; and
- the platform should be checked to ensure that it is securely stowed before travelling.

538 Fix a notice next to the controls advising on the fitting of guard rails:

- that care is needed when standing near an unguarded opening or edge;
- that loads should be pushed (as opposed to pulled) from the vehicle onto the platform; and
- about the importance of preventing loads from rolling, sliding or tipping.

Inspection of tail lifts

539 Tail lifts are lifting equipment and should be subject to ongoing thorough inspection by a competent person. These inspections must be at least every six months (or in accordance with a written scheme of examination) as required by the Lifting Operations and Lifting Equipment Regulations 1998 (LOLER). This inspection may also be referred to as a statutory 'thorough examination'.



**Se debe utilizar ropa
reflectante en todo
momento. Se negará el
acceso a todo vehículo
cuyo ocupante no
cumpla este requisito.**



Figure 31 Example of signage for visiting drivers

540 The report on the examination must detail any repairs, renewals or alterations required to enable the tail lift to continue to be used with safety, specifying whether such work is required immediately or within a specified time.

Maintenance of tail lifts

541 The LOLER inspection referred to in paragraph 540 is not the same as maintenance. The Provision and Use of Work Equipment Regulations 1998 require all work equipment to be maintained in efficient working order and in good repair. Tail lifts should be maintained in accordance with the manufacturer's recommendations. Any maintenance and repair should be undertaken by a suitably qualified person using appropriate repair techniques and procedures.

'Driveaways' or premature vehicle departures

542 Movement of a vehicle before the loading or unloading process has been completed is known as a 'driveaway'. This can cause serious accidents resulting in major injuries and fatalities. You must have a safe system of work in place so that drivers never move their vehicles (accidentally or deliberately) until the load is secure and it is safe to depart. This should be monitored regularly to ensure that it is effective.

543 Safe systems of work may include:

- proprietary vehicle/trailer restraint systems;
- interlock systems;
- keeping the vehicle keys separate from the driver until it is confirmed that it is safe for the vehicle to depart (or other custody system, eg delivery paperwork);
- a suitable traffic light system (the convention is for vehicles to move in and out on green and remain stationary when the outside light shows red); and
- competent supervisory controls, including marshals.

Refuelling

544 If refuelling is carried out on site, then the movement of vehicles into and around the area should be considered, as well as the fuel management and cleaning issues.

Weighbridges and vehicle washers

545 The location of weighbridges and vehicle washers can require vehicles to leave and join main traffic routes within a site. Any areas where vehicles are required to leave or join the main traffic routes should be carefully managed. The simplest controls may just be suitable signing and road markings ('stop', 'give way' etc) or, where vision may be restricted, consider mirrors or traffic lights.

Foreign vehicles and drivers

546 Employers are obliged to give information to staff and visitors in a form that takes account of any disability or language difficulty.

547 Signing should always follow usual road signs and other site rules can be enforced by simple pictograms. Many companies have site rules, illustrated with pictograms, prepared to cover most European languages.

Left-hand drive vehicles

548 Articulated vehicles have a very limited field of visibility past the semi-trailer when they are reversing. Consider difficulties that might be experienced if left-hand driven vehicles visit the site. These include the driver being in the wrong position to see signs and signals positioned for right-hand driven vehicles. Loading bay traffic lights should have the bay number near them, as they will be on the ‘wrong’ side for the driver.



Figure 33 Information in different languages for visiting drivers

Work at height

549 Falls are the most common cause of fatal injuries in the workplace. Many others suffer major injury such as broken bones or fractured skulls. You don't have to fall far to be hurt – a number of deaths and many major injuries each year are from a fall from below head height.

550 A significant number of employees working within the storage and warehousing industry are injured after falling. Many of these injuries could have been prevented if sensible measures had been taken.

What is work at height?

551 Work at height is work in any place, including above or below ground level, where someone could fall and injure themselves. This can be a one-off job or a routine task and can include situations:

- where people can fall from work equipment (eg using stepladders);
- where people can fall from an unprotected edge, or through an opening or fragile surface (eg transferring stock onto a mezzanine floor);
- where people can fall from ground level into an opening in a floor or hole in the ground.

What the law says

552 The Work at Height Regulations 2005⁴⁵ cover risks from falls and falling objects, both should be considered as part of the risk assessment process. Paragraphs 22–30 give more information on risk assessment.

553 Work at height should be carried out safely and employers must do all that is reasonably practicable to prevent anyone falling.

554 The Regulations set out a simple hierarchy that you should follow when assessing the need to work at height and the equipment to undertake it. This is:

- 1 Avoid work at height where this is reasonably practicable (eg use long-handled tools rather than work at height).
- 2 Prevent falls (eg work from an existing safe place or use equipment with edge protection).
- 3 Where you can't avoid working at height or prevent a fall, you should minimise the distance and consequences of any fall that might occur (eg use fall arrest equipment).
- 4 Where the risk of a fall that is liable to cause injury still remains, take other steps, such as training or giving information to reduce the risk of a fall.

555 Always consider collective protective measures before personal protective measures, ie think about suitable edge protection before a 'fall arrest' system.

Falling objects

556 The Regulations also require you to take steps to prevent people being injured by falling objects. Some common causes of items falling include:

- goods disturbed from a congested shelf;
- goods pushed through the back of a racking location due to carelessly positioned stock or excessive stock levels;
- goods falling from pallets during handling on a fork-lift truck; and
- material falling from a poorly loaded vehicle.

557 If there are areas or specific activities in the warehouse with a risk of someone being struck by material or an object, ensure that the area is clearly indicated and that unauthorised people are unable to enter it.

558 See chapter *Storage systems*, which includes steps to take to prevent items falling.

Planning and supervision

559 Any work at height, including maintenance work undertaken for you by a contractor, must be properly planned, appropriately supervised and carried out in as safe a way as is reasonably practicable. This includes planning for emergencies and rescue where necessary.

560 People involved in planning, supervising and organising work at height must be competent.

Maintenance work

561 The Regulations place duties on people in control of the work of others not in their employment. This will include where you employ contractors (to the extent that you control their activities) to carry out, for example, building maintenance or cleaning work. These duties towards contractors and maintenance workers include:

- assessing their competence (including experience, training and knowledge) and management arrangements;
- ensuring there is a good dialogue between you and the contractor so that they are fully aware of the way your site operates and its specific hazards such as fragile surfaces;
- agreeing (and in most cases writing down) the method of work, for example, the types of access equipment to be used, how it will be checked and arrangements for protecting your workers who may be nearby;
- monitoring before, during and after the work has finished.

Training

562 Make sure that everyone involved in working at height is competent (or, if being trained, is supervised by a competent person). Some access equipment will require specialist training (eg a mobile elevating work platform (MEWP) or a tower scaffold). People involved in organising, planning, supervision and the supply and maintenance of equipment should also be competent.

563 Where it is not reasonably practicable to prevent or mitigate the effects of a fall, you should provide additional training and instruction or take other measures to prevent a fall, so far as is reasonably practicable, eg safe systems of work that keep people away from an edge etc.

Duties on employees

564 Employees and people working under someone else's control must:

- report any safety hazard; and
- use the equipment supplied (including safety devices) properly, following any training and instructions.

Selecting equipment

565 If work at height cannot be avoided, when selecting the equipment to be used consideration should be given to:

- the activity and where it is to be undertaken;
- the person doing the job;
- the length of time the task is likely to take and its frequency;
- the weight/size and manoeuvrability of alternative types of equipment; and
- the relative overall risks presented by alternative solutions.

566 Stepladders or ladders are not work platforms and do not prevent falls or minimise the consequences of falls. Employers must be able to show that it is not reasonably practicable to select alternative equipment because the task is low risk and short duration.

567 Paragraphs 398–404 give more information on the use of non-integrated working platforms on fork-lift trucks. Pallets on fork-lift trucks should never be used for accessing work at height or as working platforms.

Inspection and maintenance of equipment used for working at height

568 The frequency of inspections should be determined by risk assessment (the frequency may be determined by a number of factors, such as extent of use and the environment). Inspections should also be carried out after an incident that may have affected the equipment's integrity. You should ensure that the equipment user undertakes pre-use checks for any defects that might adversely affect strength or stability.

569 Working platforms are specifically mentioned in the Work at Height Regulations and these must be inspected:

- before being used for the first time;
- periodically, by a competent person; and
- after any event affecting its strength and stability.

570 Mobile elevating working platforms (MEWPs) must be inspected at suitable intervals, with a thorough examination every six months. This is a requirement of the Lifting Operations and Lifting Equipment Regulations 1998.

571 During the periodic inspection of ladders and stepladders, you should check:

- general condition for soundness;
- legs, rails, platforms and steps where present as part of the design, to ensure that they are straight and undamaged;
- joints and hinges to ensure they are undamaged;
- hand rails, where provided, to ensure they are undamaged;
- wheels and brakes, where present as part of the design, to ensure they are in good condition;
- look for dents, distortions or sharp edges;
- wood is not damaged, cracked or painted, and no splinters are present;
- footpads are all attached and in good condition;
- stays, where required for stability, are in good condition and can be locked in place; and
- steps/rungs are clean.

572 Ensure that there is a system for reporting and managing equipment defects. This should effectively prevent the use of defective equipment, ie withdrawing defective equipment from use.

Planning for emergencies

573 The Work at Height Regulations require employers to plan for emergencies when work is being carried out at height. This includes the rescue of people who get into difficulty.



Figure 34 Mobile elevating working platform (MEWP)

Loading and unloading vehicles

574 When loading and unloading vehicles, carry out a risk assessment and apply appropriate control measures – also see chapter *Vehicles in and around the warehouse*. Particular points to consider include:

- taking care to ensure that staff, stock or equipment do not fall where there is likelihood to cause injury;
- protecting the edge with an appropriate safety rail and, where unprotected edges exist, using a bold visible line to highlight the edge;
- where edge protection is not reasonably practicable, taking measures to exclude people, other than those trained and authorised, where there is a risk of falls from height or falling objects; and
- restricting the working area of the loading bay to staff working legitimately in the area.

575 Always use the steps provided to get on and off the loading bay. Do not attempt to jump.

576 Do not manually lower cages etc down from the bay.

Mezzanine areas

577 Mezzanine floors should be clearly and conspicuously marked with their safe load-bearing capacity and any restrictions on use. They need to be carefully designed to comply with building regulation requirements, which will consider the number of people involved, the use of the area, and alternative means of escape in the event of fire.

578 In the event that pallet trucks (either hand or powered) or other wheeled equipment is to be used, the floor and structure should be designed to accommodate the static load from goods being stored on the floor and the wheel loads of the mechanical equipment, together with any dynamic effects caused by acceleration or braking forces from the equipment concerned.

579 Where people are allowed access, all openings and edges of the floor should be fenced to prevent any goods or people from falling, and a safe means of access should be provided.

580 Where new guard rails are to be installed or old ones replaced, top guard rails should be at least 950 mm in height (existing guard rails can be 910 mm if fixed in place before April 2005). The gap between guard rails should be no greater than 470 mm and toe boards should be suitable and sufficient to prevent the fall of any person or material.

581 Locations in the fencing on mezzanine areas where stock is transferred should be suitably guarded to prevent people or objects falling over the edge. A swing-over pallet gate can achieve this. Chains, tape etc should not be used as edge protection because they will not be robust enough to prevent a fall should someone stumble or inadvertently lean against them.

582 You should take steps to secure the stability of materials being lifted up to mezzanine floors, to prevent items falling (eg by shrink-wrapping).

Platforms, lofts and roof areas

583 Platforms, lofts and roof areas that are to be used for storage and access should be suitably load bearing.

584 If workers are to access these areas, there should be safe access and fencing along with adequate lighting.

585 Where access to roofs is only required for maintenance purposes and the area has not been designed for everyday use, when access is required consider:

- banning all persons other than trained maintenance staff/contractors from roof access;
- locked/signed access points;
- provision of suitable roof safety measures for use by trained maintenance personnel, and use of a permit-to-work process to ensure adequate information for users.

Stepladders and mobile stairs

586 Stepladders and mobile stairs ('aircraft steps') have many design variants and their design features should be considered when determining their suitability for a particular task or work environment. For example, some stepladders have work platforms, hand rails etc and are especially suited for use in narrow aisles, where heavier, bulkier mobile steps may be inappropriate.

587 Mobile steps can be suited to longer duration intermediate-level picking or replenishment, and maintenance work where there is space and where they do not create additional hazards (such as impeding means of escape from fire), and work at height is required to prevent overreaching during a manual handling operation.

588 Stepladders may be suitable for short-duration tasks and maintenance work where use of bulkier equipment would create additional hazards. As a guide, loads weighing more than 10 kg should not be carried on a stepladder unless justified by risk assessment.

589 When using stepladders and mobile steps:

- check them before use and do not use defective equipment;
- when in use, make sure the rungs are level and it is resting on firm, level ground;
- make sure floor surfaces are clean and not slippery;
- make sure stepladders are used for short duration light work only;
- have enough space to fully open stepladders and use any locking devices provided;
- apply the brakes (where fitted) to any mobile steps;
- do not work off the top two steps unless you have a safe handhold on the steps;
- avoid side-on working from stepladders;
- do not overreach; and
- obtain assistance if appropriate.



Figure 35 Mobile steps

Ladders

590 Using ladders incorrectly causes about a third of falls that result in major injuries. Ladders should only be used where a risk assessment shows that the job is low risk and will not last long (up to a maximum of 15–30 minutes depending on the job) or where there are features of the site which mean that other equipment cannot be used.

591 Work on a fixed or movable ladder requires at least three points of contact with the ladder. They are usually inappropriate for collection and retrieval of stock.

592 Ladders are often used when it would be better to use other equipment, eg mobile tower scaffolds, podium steps or mobile elevating work platforms (MEWPs). See *Safe use of ladders and stepladders: An employers' guide* INDG402.⁴⁶

593 If you are planning to use a ladder:

- make sure you choose one in good condition, eg no rungs are cracked or missing and the ladder feet are present and in good condition;
- do a pre-use check (including the feet);
- inspect it periodically and make sure it is maintained properly;
- do not use makeshift or homemade ladders or carry out makeshift repairs to a damaged ladder. Never paint ladders – this may hide defects;
- position it so that the bottom will not slip outwards. Use it at an angle of 75° (1 unit out for every 4 units up – the '1 in 4' rule);
- prevent slipping during use by tying the styles, using an effective anti-slip or stability device, or by footing;
- rest the top against a solid surface;
- when placing, rest the foot on a firm, level surface and make sure the rungs are level. Do not place it on material or equipment to gain extra height;
- make sure floor surfaces are clean and not slippery;
- access ladders must extend at least 1 m above the landing places unless there is a suitable handhold to provide equivalent support;
- extending ladders should have an overlap of at least three rungs.

594 When you are using a ladder:

- always grip the ladder stile when climbing;
- do not work off the top three rungs – these are to provide a handhold;
- do not carry heavy items or long lengths of material up a ladder – use it for light work only;
- carry light tools in a shoulder bag or holster attached to a belt so that you have both hands free to hold the ladder; and
- do not overreach.

Kick stools

595 These may be considered for short-duration low-level lightweight picking/replenishment, where the provision of bulkier equipment would create additional hazards. Use kick stools only on firm level ground. Before use, check that:

- the general condition is sound;
- the base unit is level;
- metal is not corroded;
- there are no dents or sharp edges; and
- rubber treads are sound and secure.

Racking

596 Racking must not be used as access equipment unless it is designed for this purpose. Climbing on racking is prohibited (unless it is specifically designed for access) – do not leave working platforms and climb into racking systems.

597 Paragraphs 631–659 give more information on racking.

Storage

Storage systems

598 A variety of systems are used for storing goods, from pallets to static racking. The method of storage depends on the shape and fragility of the article. Long thin articles are generally stored in some form of horizontal racking and box-shaped articles or loose materials in sacks built into a stack, with suitable bonding to ensure stability.

599 Cylindrical articles can be stored on their sides or on end. When such articles are stored on their sides, the floor-level tier should be properly secured to prevent movement. Subsequent tiers can rest on the preceding one or be laid on battens and wedged (see *Safety in the storage of steel and other metal stock HSG246*).⁴⁷

600 Storage areas should be specifically designated and clearly marked. The layout of the storage and handling areas should be carefully considered to avoid tight corners, awkwardly placed doors, pillars, uneven surfaces and changes of gradient. Consider the use of guard rails to protect pedestrian routes.

601 Where materials are handled by crane or lift truck, they should be placed on battens or other suitable material, so that a sling or the forks can be inserted. Pallets handled by crane should only be lifted by attachments suitable for that pallet design. A 'C'-hook pallet attachment should be used where appropriate. Where fork-lift trucks are used, it is possible for most materials to be palletised and stacked as complete pallet loads, or stored on pallet racking.

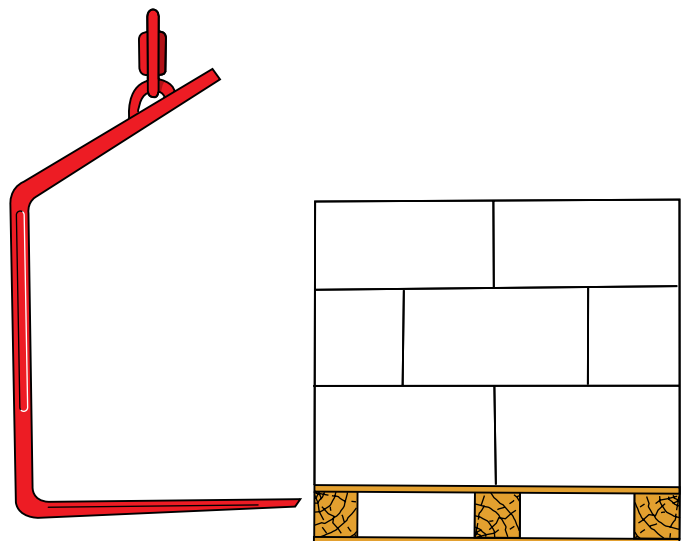

Figure 36 'C'-hook pallet fork attachments can improve handling of pallets by cranes

Pallets

602 A pallet is a portable platform, with or without super-structure, for the assembly of a quantity of goods to form a unit load for handling and storage by mechanical means. They are widely used for the storage and transit of goods.

603 A reversible pallet is a pallet with similar top and bottom decks, either of which would take the same load. They are not suitable for use with hand-pallet trucks, as the small wheels on the forks will cause damage and separation of the bottom deck.

604 A wing pallet is a flat pallet whose deck (or decks) project beyond the outer bearers to facilitate the use of lifting slings. They are not suitable for drive-in or drive-through racking where the dimension between racking beam rails has to match the overall width of the pallet, as the wings are not strong enough to support substantial loads.

605 Flat pallets, post pallets and box pallets are the most common types of pallets used in warehouses.

606 A cage pallet is a special design of pallet that has a superstructure of four attached collapsible vertical sides, usually slotted or mesh. Such pallets are designed to permit stacking by mechanical means. They can be used both for transit of goods and as a display and selection unit for merchandising in retail outlets, ie goods can be put on sale without further unpacking and handling.

607 Pallets can be constructed from a number of materials, such as steel, plastic or timber. Flat pallets are usually constructed of timber. Pallets should be of sound construction, sound material and of adequate strength. It is recommended that pallet design should satisfy the requirements of BS EN 13698. Worldwide, the design and dimensions of pallets vary.

608 If pallet racking is used in the warehouse, the type is of key importance when considering which type of pallet to use. Consider the bending stresses exerted on timber, flat and other pallets from this type of storage.

Using flat pallets

609 Flat timber pallets form an essential part of many mechanical handling systems in warehouses. Accidents directly attributable to these pallets usually arise from six main sources:

- poor design;
- poor construction;
- the use of a pallet which is unsuitable for a particular load;
- the continued use of a damaged pallet;
- bad handling; or
- the use of a pallet which is unsuitable for a particular racking system.

610 The majority of pallets are designed for carriage of a particular class or type of goods and to be handled or stored by a particular method, eg a pallet intended for the carriage of boxed cereals, handled by a lift truck and stored singly in racking, will not usually be suitable for goods such as cans of paint, lifting by bar sling or for stacking four high. A pallet designed specifically to carry evenly distributed loads, such as boxed cereals, may not be strong enough to carry concentrated loads, such as an electric motor of the same weight.

611 Where mixed racking systems are installed within a single warehouse, the use of pallets which require a different orientation for each racking system, eg a four-way entry pallet without base members 'x', are not be regarded as suitable. Use a pallet design that is suitable for all your racking systems, regardless of orientation.

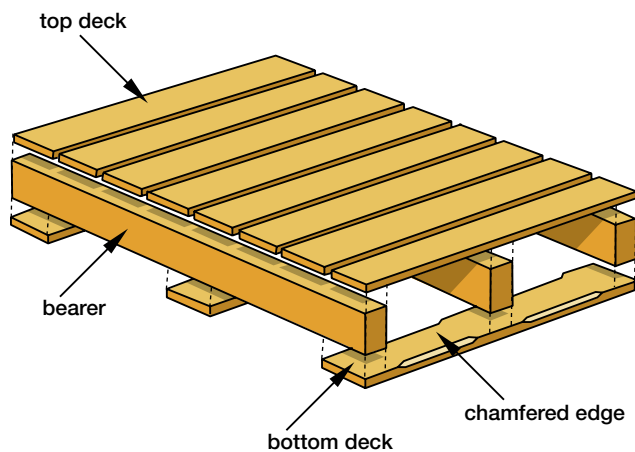
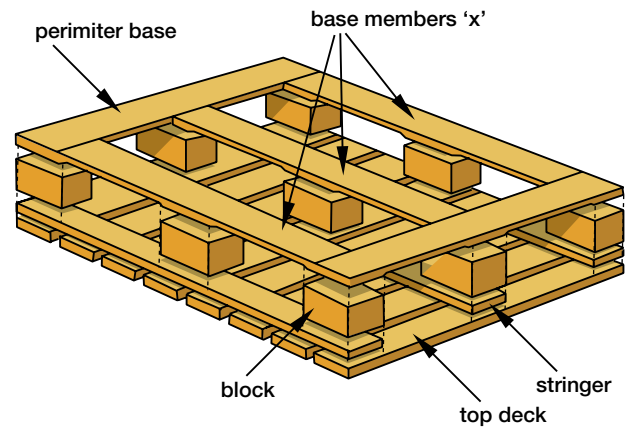

Figure 37 Flat pallet (a) two-way entry non-reversible (topside view). A pallet whose bearers permit the entry of forks from two opposite directions only



Flat pallet (b) four-way entry (underside view). A pallet whose blocks permit forks to enter from all four directions. Some pallets are designed without base members 'x'

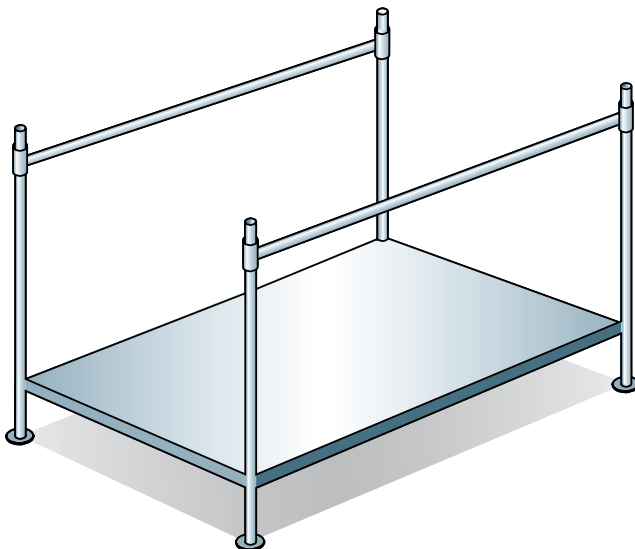

Figure 38 Post pallet

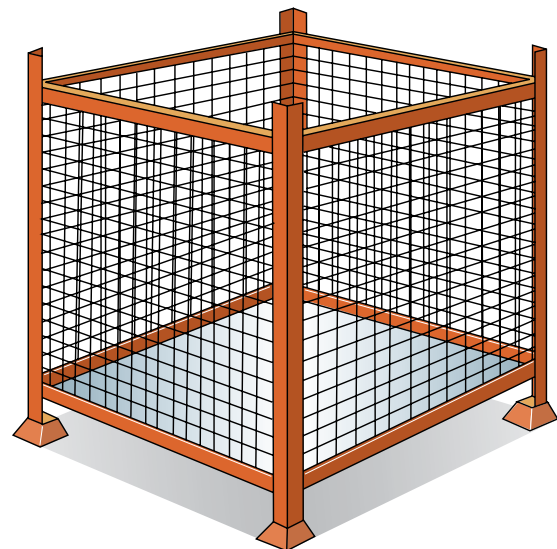

Figure 39 Box pallet

Loading pallets

612 Pallets should be loaded to an established pattern designed to achieve maximum stability and safety within the rated load. Loads should be applied gradually, and unless the pallet has been specifically designed for point loading, should, as far as possible, be uniformly distributed over the deck area. As a general guide, the load height should not exceed the longest base dimension of the pallet.

613 Shrink or stretch wrapping the load usually provides greater security, minimising the possibility of movement of goods – it may be possible, in certain circumstances, to safely transport loads taller than the largest base dimension of the pallet, eg palletised loads approximately to the internal height of closed vehicles. This should only be done where you have carefully assessed the stability of the load components, the load configuration and any special features such as wrapping, strapping etc.

Stacking palletised loads (block stacking)

614 Avoid stacking palletised loads of cartons and packs that are capable of being crushed, as the strength and stability of the stack cannot be maintained. Loads that are capable of being stacked directly on top of each other should be positioned on a firm level base. It may be necessary to provide additional packing on top of the lower palletised load, depending on the characteristics of the load and design of the pallet.

615 Generally, such stacks should not be more than a 4:1 ratio between height of stack and the minimum depth/width of pallet. Four loads high might also be considered a maximum due to the potential problem of crushing the goods on the bottom pallet. In some circumstances, dependent on the height, strength and stability of the loads, taller stacks may be built. The maximum permissible height may be up to six loads high, provided that the pallet itself and the packaging of the stored goods are designed to exceed the four-high strength.

616 Maintain adequate clearance between rows to ensure safe stacking and withdrawal. Check stacks periodically for stability and take corrective action where necessary.

Figure 40a–d Common pallet handling faults can damage deck boards

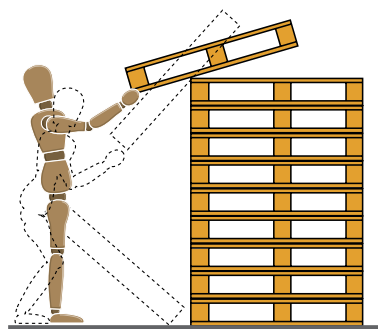

(a) Any sliding or dropping action should be avoided

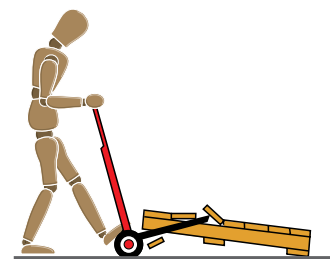

(b) Misuse of a sack truck can loosen boards

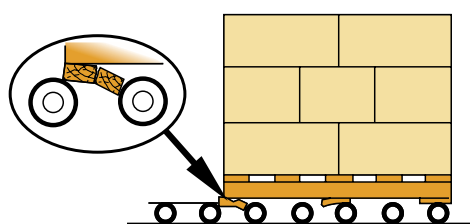

(c) The spacing of pallet conveyor rollers should be less than that of pallet base members otherwise jamming could occur



(d) Ramps and bumpy floors can cause loads to be jolted and bases of pallets to be grazed

Safe pallet use

617 Consider the following for safe use of pallets:

- You should have an effective system for pallet inspection. Damaged pallets should be removed from use.
- All pallets should be inspected each time before use, to ensure that they are in a safe condition. Withdraw damaged pallets for suitable repair or destruction.
- Empty pallets should be carefully handled and not dragged or thrown about. They should not be handled by methods likely to loosen deck boards. Wedging the platform of a sack barrow between top and bottom deck boards can cause damage.
- Hand-pallet truck forks of unsuitable length can cause baseboard damage and be dangerous to workers.
- If hand-pallet trucks are used, take care to ensure that the small finger wheels (also known as trail or guide wheels) do not damage the base boards. Chamfered edges to the bottom deck boards will assist entry of the pallet truck fork arms.
- Expendable pallets, ie pallets designed for one delivery only, should be clearly marked to this effect and are not normally suitable for storing on racking. They should not be reused.
- Take care when using strapping to secure loads to pallets, as deck boards can be pulled from the bearers.
- To avoid damage to pallets and to lift palletised loads safely, the forks of a handling device should extend into the pallet to at least 3/4 of the pallet depth.
- The forks should not extend beyond the pallet, as protruding forks could:
 - make contact with or lift an adjacent load(s), causing it to overturn or collapse; or
 - find their way underneath a fixed structure (eg racking) during lifting, causing overloading of the truck and/or serious damage to the racking structure.

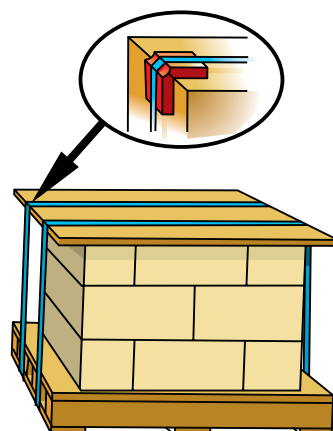
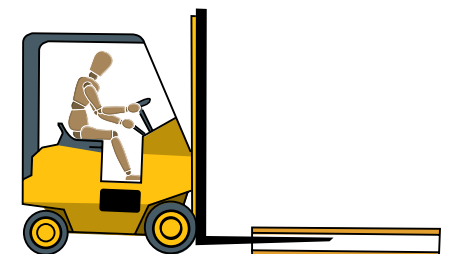
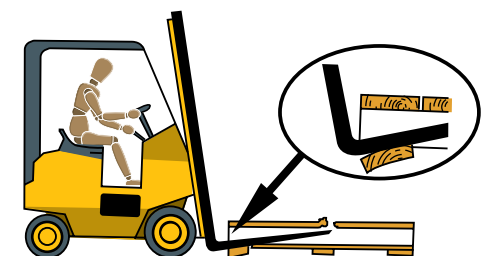

Figure 41 Load packaging. Dunnage and other methods can improve load packaging



(a) Mast should be absolutely vertical



(b) Mast should not be tilted backwards until forks have fully entered and lifted the pallet

Figure 42 Correct procedure for entering a pallet

618 Only authorised, trained and competent people should operate lift trucks (see paragraphs 413–416 for more information).

619 Instruct operators on the correct method of handling pallets, emphasising:

- the mast should be in the vertical position when entering and leaving the pallet, forks should be level with the pallet boards;
- the pallet should be positioned against the heel of the forks;
- the forks should enter the pallet squarely;
- the forks should be correctly spaced for the pallet load being lifted;
- pallets should not be pulled or pushed along the ground;
- loads should be carefully and gently placed on the stack below;
- pallets should be lowered onto racking beams, and never slid across or along the top surface of such beams.

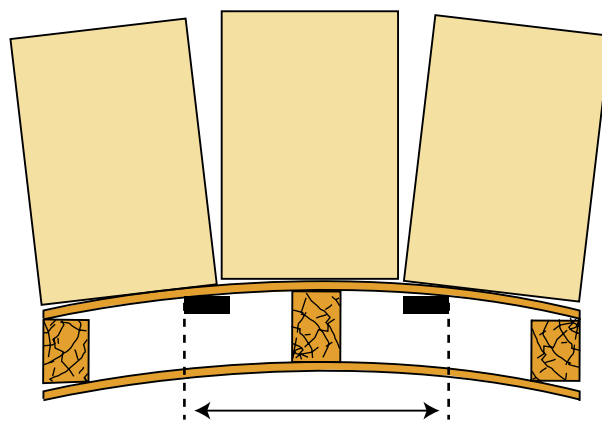

Figure 43 Optimum distance between forks should be known in relation to pallet size

Turntable pallet stretch-wrap machines

620 These machines are commonly used in warehouse premises to wrap a pallet load in a sheet of plastic film to provide stability, weatherproofing and protection to the load during storage or distribution. The pallet load is usually placed onto the machine turntable using a lift truck or pallet truck; the plastic film is then attached to the pallet load manually, eg by tying to the pallet, and wrapping is carried out by rotating the load on the turntable while the film reel is carried vertically up and down on a column. Some machines are fitted with a top clamp, which descends to steady the pallet load while the wrapping cycle is carried out.

621 Common hazards associated with the use of turntable pallet stretch-wrap machines include:

- trapping a person's body between the moving pallet load and the fixed structure;
- trapping a person's body between the moving pallet load and fixed parts of the machine;
- trapping a hand by moving parts, eg drive mechanisms, chain, and sprockets;
- trapping a foot between the power-driven turntable and its surround;
- trapping a foot between the underside of the film reel carriage and floor or framework of the machine; and
- trapping a hand or arm between the top clamp and the load.

622 The following safeguards should be adopted when turntable pallet stretch-wrap machines are used:

- Ensure that the area around the turntable to a minimum distance of 500 mm (1000 mm is recommended) from the turntable edge is level and marked with fluorescent orange-red or 'safety colour' yellow and black lines (see BS 5499 Part 5). This area should be clear of obstructions to allow safe access for trucks to load and unload. Adopt a suitable system of work to avoid the danger of overhang, eg by ensuring correct positioning of the pallet and ensuring that the pallet is of the appropriate size.
- There should be a minimum horizontal clearance of 500 mm between the turntable edge and any fixed parts of the machine or film reel carriage.
- The turntable drive mechanism should be completely encased.
- Provide suitable fixed guards for chains and sprockets in the film reel carriage column. Guarding may not be necessary where the film reel carriage is moved by means of a collar driven by a protected lead screw.
- The turntable should be circular to minimise the risk of foot trapping, and any gap between the turntable and its surrounds should not exceed 5 mm.
- To prevent trapping a foot between the underside of the film reel carriage and the floor or other fixed framework of the machine, a clearance of at least 100 mm should be maintained. Where this is not possible, provide a suitable trip device that will stop the motion of the film reel carriage. The film reel carriage should not restart automatically if stopped by a trip device; positive restart action, eg the operation of a 'start' button, should be necessary after the obstruction is removed. Similar protection is required between the film feed carriage and the top clamp support at the other end of the carriage travel, unless safe by position.
- To prevent entrapment between the top clamp and load, the underside of the clamp should be covered with suitable resilient material at least 25 mm thick. This should be renewed if its resilience deteriorates. The top clamp pressure should be limited to prevent or reduce the risk of injury if a person's arm comes between the top of the pallet load and underside of the top clamp.
- To allow for uneven loading, the diagonal measurement of the largest pallet load should be at least 100 mm less than the diameter of the turntable, eg for a standard 1200 mm by 1000 mm pallet, the turntable size should be 1690 mm diameter.
- Controls and switches should be grouped and mounted in one panel, clearly marked to indicate their function and mode of operation, and situated to allow the operative to occupy a safe position with full view of the load.
- Provide easily accessible emergency stop buttons that are of the palm or mushroom type, and coloured red. Once operated, the stop buttons should remain in operation until reset.
- As an alternative to safeguarding the hazards individually, locate the turntable column and film reel within an interlocked enclosure.

623 In some specialised warehousing situations, pallet wrappers or strappers that are conveyor-fed and operate automatically (including those where the pallet remains stationary while the reel passes round it on a rotating arm) may be found. Such machines generally require a higher standard of guarding, and as a minimum, should be provided within interlocked enclosures.

624 Further advice on the principles of safeguarding relevant to these machines may be found in *Industrial robot safety* HSG43.⁴⁸



Figure 44 Stretch wrapping machine

Pallet inverters

625 These mechanically operated machines are designed so that a defective pallet at the bottom of a palletised load can be easily removed and replaced with a sound pallet, without the need to de-stack the load by hand. They may also be used to change from one type of pallet to another. Pallet inverters should only be used where a pallet carries non-crushable materials stacked in a manner that allows inversion. The basic operation is as follows:

- 1 Palletised load with defective pallet placed onto the machine platform by lift truck or pallet truck.
- 2 Load clamped between platform and top plate.
- 3 Load inverted by machine.
- 4 Clamping mechanism released.
- 5 Pallet removed and replaced as required.
- 6 Palletised load re-clamped.
- 7 Load inverted back.
- 8 Platform descends with palletised load to original position.



Figure 45 Pallet inverter

626 Hazards at pallet inverters are known to include:

- the trapping points between the dangerous moving parts of the pallet inverter;
- the trapping points between the moving parts of the pallet inverter and its fixed structure;
- the trapping points between moving parts of the pallet inverter and the fixed structure of the building or structures surrounding the pallet inverter;
- the trapping points between the moving platform and the palletised load; and
- the trapping points between the moving platform and the ground or loading bay during descent.

627 After assessing the risks associated with the use of pallet inverters, you should adopt the following precautions:

- The pallet inverter should only be used by trained and authorised personnel. It should be located in a suitable part of the warehouse where unauthorised employees can be excluded from its area of operation.
- Provide interlocked enclosure guards. The enclosure guards should be designed, installed and adjusted so that:
 - until the guard is closed, the interlock prevents the machinery from operating by interrupting the power;
 - either the guard remains locked closed until the risk of injury from the hazard has passed, or opening the guard causes the hazard to be eliminated before access is possible (ie the machine comes to rest before access is possible).
- Operators should be trained, instructed and competent in the correct method of using the machine and be made aware of the potential dangers.

Pallet converters

628 A pallet converter is a frame (usually metal) that fits onto a wooden pallet to enable crushable or unevenly shaped loads to be stacked. The pallet converter should be rigid even without a load or with a part load, and you should not rely on a full load to ensure rigidity.

629 Locking pins or other devices used to locate and lock the converter onto the pallet should be in good working order and free from defects. To ensure the pallet converters are in a condition to be stacked safely, there should be an effective system of control over pallets and component parts of converters that ensures all the component parts are compatible with each other. Damaged or defective pallet converters should not be used.

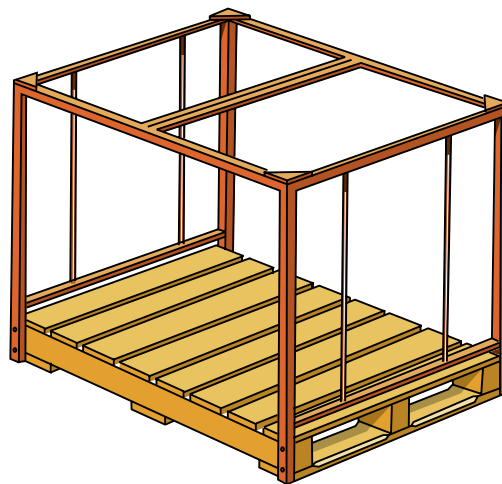

Figure 46 Pallet converter

Trolleys or roll containers

630 Paragraphs 364–378 give more information on trolleys and roll cages.

Racking systems

631 The term ‘racking’ is used to describe a skeletal framework, of fixed or adjustable design, to support loads generally without the use of shelves. It is usually qualified (ie pallet racking, tyre racking, drum racking, etc). Racking systems are widely used in warehouses as there are considerable space advantages over floor storage and they provide for easy access and retrieval of goods. There are many different types of racking system. The most common types found in warehouses are described in Table 9. Table 10 details terms commonly used for racking systems.

632 The glossary of terms and certain definitions used in Tables 9 and 10 have been reproduced by kind permission of the Storage Equipment Manufacturers’ Association (SEMA) from their publication *Terms and descriptions of storage equipment*.⁴⁹

633 All racking systems should be of good mechanical construction, of sound material, adequate strength and installed and maintained in accordance with the manufacturer’s instructions. The maximum safe working load and design configuration for any racking installation should be conspicuously displayed (see paragraph 634).

Racking system	Description
Adjustable pallet racking	A system of upright frames connected by horizontal beams to provide pallet storage levels, which can be adjusted vertically. Each pallet storage position can be accessed individually.
Mobile racking	The racking is mounted on movable base frames running on rails; it can be power-operated, manually operated or mechanically assisted.
Cantilever racking	Racking incorporating cantilever arms, either fixed or adjustable.
Live storage racking	A live storage system provides a block of storage in depth, which has a rear or ‘loading face’ and a front or ‘picking face’. Goods are conveyed from the loading to the picking face either by gravity using an inclined surface or track or by horizontal powered conveyor such that two aisles are necessary to service a block of storage, whatever the depth. This method of storage ensures that the first-in-first-out system operates and is suitable for pallets, boxes, and containers etc, all of which have specific requirements within a live storage system.
Push-back system	A live storage system providing a block of storage in depth, where picking and loading are both done from the front face of the block. Goods are conveyed to and from the storage position either by gravity using an inclined surface or track or by horizontal powered conveyor such that only one aisle is necessary to service a block of storage. This method of storage ensures that a first-in-last-out system operates and is suitable for pallets only.
Drive-through/ drive-in racking	This system provides blocks of static storage where pallets are stored two or more deep. By driving into the storage lane, access is gained to pallets supported along their sides on beam rails cantilevered from the frames. Drive-in system: the lift truck drives into a lane and reverses out. Drive-through: similar to drive in, but the truck may drive through the block from one aisle to another.

Racking installation

634 The requirements for the safe installation of racking vary according to the type and size of the system, and the nature of the building or area for which it is intended. Safe working loads, heights, widths and equipment tolerances should be set by the designers and manufacturers of the total system. The basic principles for safe installation are as follows:

- Racking should only be installed by competent people in accordance with the manufacturer's instructions. A programme of installation training is run under SEIRS (Storage Equipment Installers Registration Scheme), which is run by SEMA. There is more information on the SEMA website.
- Racking should be erected on sound, level floors, capable of withstanding the point loading at each base plate.
- Where the racking design requires it to be secured to the building, only those building members that have been 'proved', by structural calculations, as able to resist the forces applied should be used. In such a case, the racking design should be compatible with the building layout.
- Double-sided runs should be connected and spaced using suitable run spacers.
- Where necessary, eg where lift trucks or other mechanical handling equipment are used, racking should be securely fixed to the floor (see paragraphs 636–638).
- Aisles should be wide enough to ensure that mechanical handling equipment can be easily manoeuvred. Widths will depend very much on the type of equipment used, eg some require a 90° turn to load and offload, some remain parallel to the aisle and have forks at 90° to the direction of travel.
- Beam connector locks should always securely fix the connectors at the ends of each beam, to prevent accidental uplift of beams, eg by lift truck.
- Racking should have a clear unambiguous notice securely fixed to it, stating the maximum load together with any necessary specified load configurations. A typical notice is shown in Figure 48 and more examples for other types of racking can be seen in the SEMA publication *Load notices*.⁵⁰ See also the SEMA publication *Recommended practices for the safe use of static pallet racking*.⁵¹
- The limitations indicated in the maximum load notice should never be exceeded. The weight of each palletised load should be established before a decision is made to store it in the racking. This is particularly important where different products are stored which may vary considerably in weight, or where a new line of product is brought into the warehouse for the first time. In some situations, it may not be necessary to establish the weight of each palletised load, if the racking system is designed and installed to meet the storage requirements of the heaviest palletised load in your company's operation. Nevertheless, you should adopt a system to ensure that all palletised loads intended for storage in racking can be safely stored in accordance with the particular racking design and installation.
- Racking should never be altered (eg by welding) nor components removed without first consulting the manufacturer. Before changing the position of adjustable components on racking (as supplied), you should establish the design limitations of the new configuration and, where necessary, amend the safe working load notice. Adjusting the position of the first or second beam from the bottom is normally the most critical alteration, which always requires a check on the rated carrying capacity of the rack.
- High visibility colours for key components of the racking, eg horizontal beams, will assist truck operators to correctly position the forks and avoid damage to the racking.

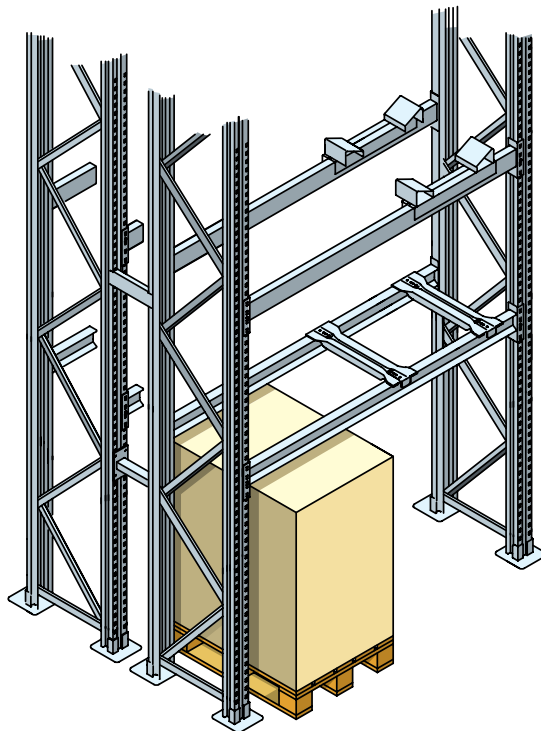

Figure 47 Adjustable pallet racking

Pallet stops

635 Using pallet stops attached to racking structures may increase the risk of structural damage from the load or thrust that may be applied to the racking. If racking layouts are correctly designed to give adequate clearances between back-to-back pallets or loads, then pallet stops are unnecessary for a trained and competent driver to deposit a pallet correctly and safely.

Racking stability

636 The main factors that influence the stability of the racking installation are the height-to-depth ratio and whether it is fixed to the floor or other suitable parts of the building structure. Free-standing racks (ie not fixed to the floor) should not be used in areas where lift trucks, order pickers or other mechanical handling devices are used.

637 Where racks are subject to imposed loads from the storage of product, plus horizontal loads from loading and unloading, the minimum requirements for floor fixings should be:

- floor fix all uprights adjacent to aisles and gangways, where the height/depth ratio does not exceed 6:1. In this case, the rack height should be assessed as the height to the top of the topmost beam. While the depth of the rack should be taken as the overall depth of the frame or in a back-to-back situation, it can be taken as the depth of the two frames plus the length of the run spacer, providing that these are located at not more than 2.5 m centres.
- floor fix all uprights where the height/depth ratio exceeds 6:1 but does not exceed 10:1;
- where ratios are greater than 10:1, the manufacturer should provide specific guidance.

Table 10 Glossary of terms used in adjustable pallet racking systems	
Term	Description
aisle	Space giving access to picking or loading faces
base plate	Fitted to base of upright for floor fixing, or load spreading
bay	A module between upright frames
beam	Horizontal load-carrying member, fitted with a connector at each end for engagement with holes at predetermined increments in the frame upright
beam connector lock	A device for preventing accidental uplift of beams
block, when used to describe:	
mobile racking	A number of mobile runs, usually with one aisle
live storage racking	A number of connected bays, each racking providing storage in depth
push-back racking	A number of connected bays, each racking providing storage in depth
drive-through/drive-in	A number of connected bays
frame	Two or more uprights, joined by bracing members
gangway	Space for movement or transport but not giving direct access to picking or loading faces
levels	Number of storage levels in the height
pallet stop	A component positioned at the rear to ensure that a pallet is correctly positioned on the support beams. (Note: Use is not recommended – see paragraph 635)
run	A series of bays connected lengthwise
single-sided run	Single depth of rack, usually accessible from one side only
double-sided run	Two runs built back-to-back
run spacer	A member connecting and spacing two back-to-back runs of racking
wall tie	A fixing between rack and wall to provide spacing and/or stability

638 For increased safety, many racking suppliers consider it prudent to secure all uprights to the floor. Floor fixing should be such that the anticipated horizontal shear and vertical tensile forces can be safely resisted. Drive-in and drive-through racks should always be designed and floor fixed according to the manufacturer's instructions.



Conduct regular inspections to check for:

- correct application and use
- loads within allowable safe limits
- accidental damage, or dislodgement of structural components



REPORT ALL DAMAGE TO THE 'PERSON RESPONSIBLE FOR SAFETY'



Do not alter the structure without either:

- checking effects against manufacturer's 'technical data'
- obtaining approval from supplier



DO NOT CLIMB RACKING



Refer to 'Steel static storage systems adjustable pallet racking guidelines for safe use'



If in doubt **ALWAYS** contact supplier

Date supplied: 01.01.2005	Project ref: 1234
------------------------------	----------------------

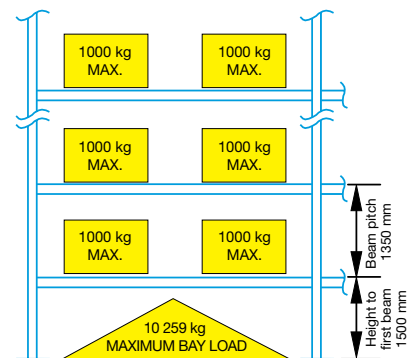

All loads to be uniformly distributed

Equipment supplied by:

Figure 48 Example of racking notice

Racking protection

639 Where racking is likely to be struck by lift trucks and other vehicles, it should be protected. Generally, such damage is at the lower levels of the racking – use renewable column guards to minimise the risk of damage from accidental impact. Corner uprights in a run of racking are especially at risk and should be suitably provided with a protective device in a conspicuous colour.

640 Retrofitting upright protection devices to an existing aisle where they have never been provided can have the effect of reducing the available clearances for fork-lift truck manoeuvres, which can in some circumstances increase the amount of damage caused. Such situations need consideration on a case-by-case basis.

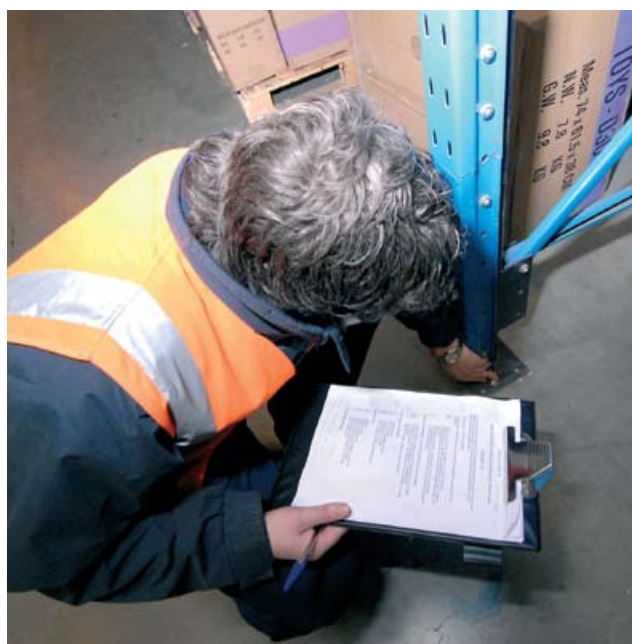
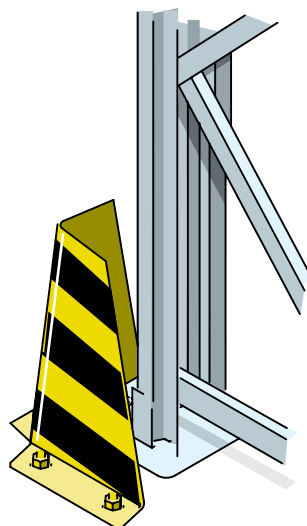

Figure 49 Post protection

Figure 50 Racking being inspected

Racking inspection and maintenance

641 In general, racking is manufactured from relatively lightweight materials and, as a consequence, there is a limit to the amount of abuse that it can withstand. The skill of lift truck operators has a great bearing on the amount of damage likely to be caused. Any damage to racking will reduce its load carrying capacity. The greater the damage the less its strength will be.

642 To ensure that a racking installation continues to be serviceable and safe, the storage equipment should be inspected on a regular basis. The frequency of inspections depends on a variety of factors that are particular to the site concerned and should be determined by a nominated 'person responsible for racking safety' (PRRS) to suit the operating conditions of the warehouse. This will take into account the frequency and method of operation together with the dimensions of the warehouse, the equipment used and personnel involved, all of which could damage the structure. The inspection follows a hierarchical approach using several levels of inspection.

Immediate reporting

643 As soon as a safety problem or damage is observed by any employee, it should immediately be reported to the PRRS. You should have systems in place for reporting damage and defects.

644 Employees should receive training, information and instruction on the safe operation of the racking system, including the parts affecting their safety and the safety of others.

Visual inspections

645 The PRRS should ensure that inspections are made at weekly or other regular intervals based on risk assessment. A formal written record should be maintained.

'Expert' inspections

646 A technically competent person should carry out inspections at intervals of not more than 12 months. A written report should be submitted to the PRRS with observations and proposals for any action necessary.

647 A technically competent person might be a trained specialist within an organisation, a specialist from the rack supplier, or an independent qualified rack inspector.

648 A programme of rack awareness training is run regularly by SEMA to address the issue of visual inspection and a more formal course is run to qualify expert inspectors under the SARI (SEMA approved rack inspector) scheme.

649 Normal rack inspections will be carried out from ground level unless there are indications of problems at high level that need investigation.

650 Automated and high-bay systems, however, while less prone to damage at high level, require inspection and the higher levels cannot be seen from the ground. Formal inspection of these systems should include the following:

- an immediate written reporting system by the maintenance engineer who will have day-to-day responsibility for the system to ensure that the quantity and scale of any problems can be analysed by the PRRS;
- an expert inspection every 12 months consisting of a minimum of 20% of the installation carried out on a rolling basis so that the complete installation is inspected every five years as a minimum requirement;
- an appraisal of the problems found by the inspection should be carried out by the PRRS to identify if a more wide-ranging inspection is necessary. The racking manufacturer should be contacted for advice if there is any uncertainty as to the integrity of the racking system.

651 You should keep a record of inspections, damage and repairs. This could be done in a logbook.

652 Where damage is identified that affects the safety of the racking system, the racking should be offloaded and controls introduced to prevent it being used until remedial work has been carried out. Table 11 gives information on the classification of damaged racking.

Table 11 Classification of damaged racking		
Risk level	Status	
Green	Requiring surveillance only	Green level indicates the limit that does not require a reduction in rack carrying capacity or an immediate repair of the system. This would indicate racking components that are considered to be safe and serviceable. Such components should be recorded as suitable for further service until the next management inspection but should be clearly identified for specific re-examination and reassessment at future inspections. Exceeding the green level should be considered damage and causes risk to the racking system.
Amber risk	Hazardous damage requiring action as soon as possible	This would identify an area where the damage was sufficiently severe to warrant remedial work but not so severe as to warrant the immediate offloading of the rack. Once load is removed from a damaged component, the component should not be reloaded until repairs have been carried out. The user should have a method of isolating such racks to ensure that they do not come back into use until the necessary repairs have been carried out and the equipment certified as safe. For example, use dated adhesive labels, which indicate racks that are not to be reloaded until rectified. Any racking with amber risk category damage should be redesignated red risk if remedial work has not been carried out within four weeks of the original designation.
Red risk	Very serious damage requiring immediate action	These are situations where a critical level of damage is identified which warrants an area of racking being immediately offloaded and isolated from future use until repair work is carried out. Such repair work would usually be by replacement of the damaged component. You should have a method of isolating areas to ensure that they do not come back into use before the repair work is carried out. For example, a particular bay could be offloaded in the presence of the inspector and roped off to prevent further use.

653 Detailed guidance on this classification of damage is available in the SEMA publication *Guide to the conduct of pallet racking and shelving surveys*.⁵²

654 Where possible, avoid manually handling goods and stock (see chapter *Manual handling* for more information). In most warehouses, mechanical handling devices (eg lift trucks) are used to place and retrieve stock from racking.

Placing or receiving stock from racking or shelving

655 Where it is necessary to place or retrieve stock from racking by hand, the following basic principles should be adopted:

- access to the racking or shelving should not be by climbing the racking or shelving;
- where access equipment is to be used, this should be done safely;
- mechanical handling plant should not operate in the proximity of workers who are engaged in such operations.

656 See chapter *Work at height* for more information on the risk of falls from height and the use of ladders.

Picking from in-rack walkways

657 Mezzanine floors can be provided between racking runs so that products can be picked or replenished at more than one level. This increases the picking locations in a given floor area where numerous operators can pick simultaneously. Typically, pallet racking is used where the replenishment side is fed by fork-lift truck and manual picking the other side. This can be single/double pallet depth or using live storage for greater capacity.

658 In addition to the general risks associated with working at height, care should be taken to ensure that workers are protected at picking locations:

- a shelf (timber or mesh) should be provided at the mezzanine level picking location to ensure that, when a pallet is not in a location, an operator cannot fall into the aperture created by the removal of a pallet;
- there should also be a protective rail provided at the lower-level picking location to ensure that an operator cannot approach the open edge.

659 EN 528 may be of use.

Automated storage and retrieval systems

660 Automated storage and retrieval systems include a variety of methods for automatically placing and retrieving loads from specific storage locations, and include equipment such as:

- horizontal carousels;
- vertical carousels;
- vertical lift modules; and
- traditional crane-in-aisle storage and retrieval systems.

661 The systems are categorised into three main types – single masted, double masted and man aboard (which can be equipped with a picking platform).

662 Items are delivered and removed from an automatic storage and retrieval system at stations which provide precise pickup and delivery points where the loads are transferred to/from conveyors or automatic guided vehicles (AGVs).

663 A schematic layout of one type of automated and semi-automated warehouse is shown in Figure 51. It comprises a reception point where palletised goods are placed onto mechanical handling devices (eg lift trucks, conveyors, automatic guided vehicles), which are then taken to a transfer point where the palletised goods are transferred onto a storage and retrieval machine and placed onto storage racking. The retrieval of palletised goods from the storage racking is the reverse procedure.

664 You should carry out a design risk assessment of the equipment, its installation and its systems during the design and construction phases. You should also carry out hazard analysis and risk assessment before the equipment is used for the first time, to ensure that people are adequately safeguarded. Paragraphs 22–30 give more information on risk assessment.

Hazards in an automated storage system

665 Hazards in an automated system include those between reception and transfer points. For hazards associated with lift trucks and conveyor systems, see the chapter *Manual handling*. Also refer to BS EN 528:2006 *Rail dependent storage and retrieval equipment*.

666 Hazards associated with the use of automatic guided vehicles (AGVs) include:

- collision between AGVs and people;
- trapping points between AGVs and stationary objects or fixed structures; and
- dangerous occurrences by inadvertent movement of the AGV, eg where AGVs interact with storage and retrieval machines. The AGV could move off before the load transfer is complete, causing displacement or collapse of the load or other devices.

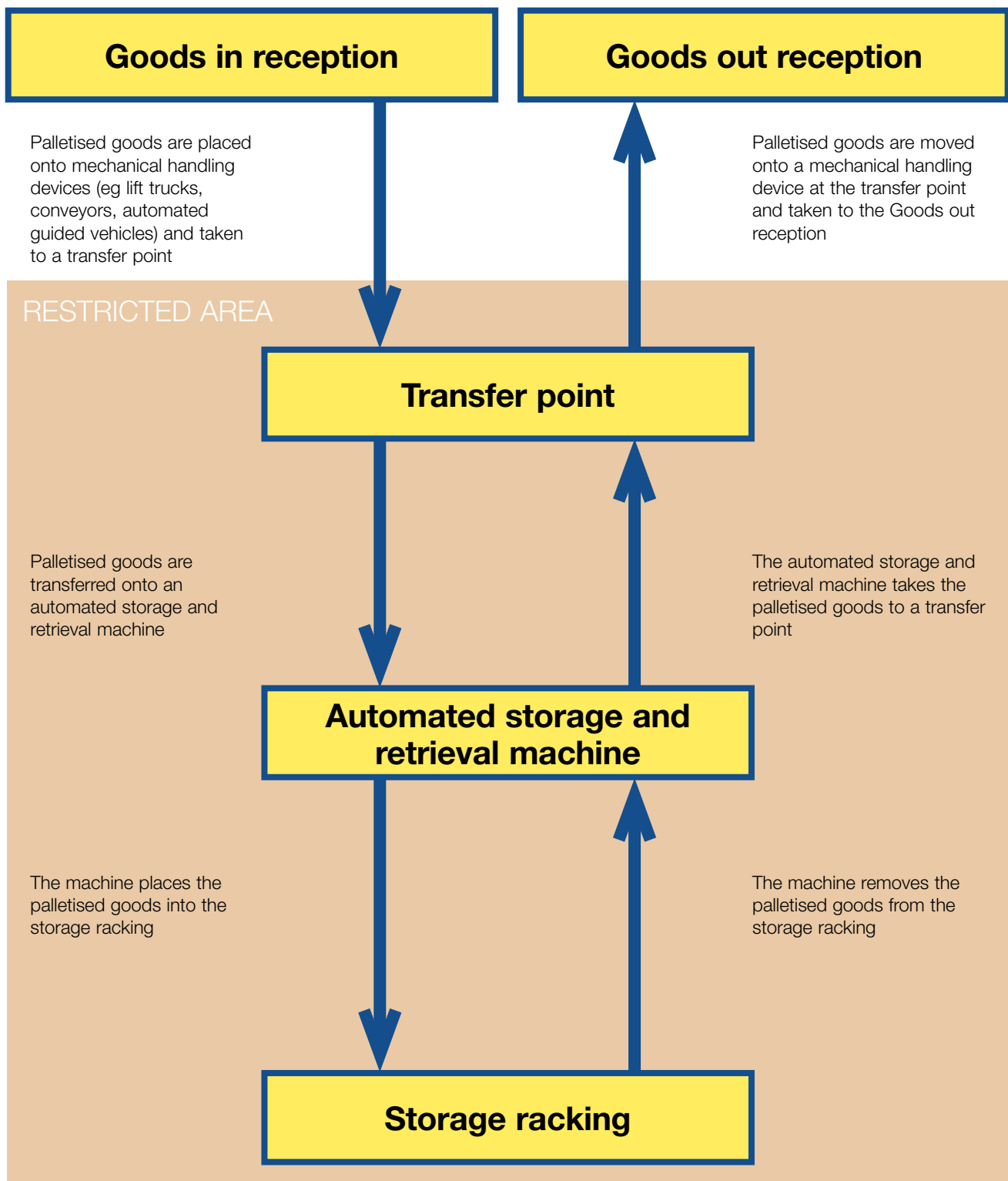

Figure 51 Diagram of an automated storage and retrieval system

667 Hazards at transfer points include:

- trapping points between mechanical handling devices, palletised loads and the structure of the transfer point;
- collapse of the palletised load; and
- trapping points between an automated storage retrieval machine, palletised load, mechanical handling devices and the structure of the transfer point.

668 Hazards in an automated storage area include:

- being struck by an automated storage and retrieval machine;
- trapping points between automated storage and retrieval machines and fixed structures, eg racking;
- trapping points between dangerous moving parts of the automated storage and retrieval machine;
- trapping points at transfer points for goods, eg transfer arms, transfer pallets;
- trapping points at transfer points for automated storage and retrieval machines which serve more than one aisle (movement of stacker onto transfer bogey, movement of the transfer bogey);
- collapse of an automated storage and retrieval machine or load, also part of load;
- fall of a load (eg due to poor placement of the load);
- overrun of automated storage machine in horizontal or vertical travel;
- inadvertent movement of an automated storage and retrieval machine (eg by maintenance technician unaware of position of co-worker); and
- fall from height (eg maintenance technician during recovery or routine servicing).

669 You should carry out a hazard analysis and risk assessment:

- when a new process is being introduced;
- when there has been a significant change in process; and
- in any case, review at appropriate intervals.

670 Hazard analysis and risk assessment should be undertaken by a competent person or persons. It should also involve operators, users and maintenance.

Risk assessment procedure

671 Follow HSE's five step approach to risk assessment, detailed in paragraphs 22–30. If the risk is too high, propose safety measures and re-evaluate the risk until it is at an acceptable level.

672 Describe the limits of the machine for the relevant phase of life:

- intended use;
- foreseeable misuse;
- space limits;
- competence of user; and
- maintenance activities.

Safeguarding automated and semi-automated systems

673 The type of hazard created and the level of risk will determine which safeguard(s) are appropriate. Further advice on the principles of safeguarding relevant to automated systems can be found in the relevant British Standards listed in *Further reading*.

Between reception and transfer points

674 Safeguards for lift trucks and conveyor systems are described in chapters *Mechanical handling* and *Manual handling*.

675 Where AGVs are used, safeguards include:

- segregating AGV operating areas from pedestrian traffic;
- provision of trip devices in the vehicle's direction of travel, such as front and rear bumpers, which will stop the movements of the AGV if depressed. Trip devices should be designed with flexible bumpers to ensure that the vehicle stops before the object touching the bumper is reached by the main structure of the vehicle. Front and rear optical devices can also be used;
- provision of trip whiskers, probes or optical devices along the sides which will stop the vehicle when activated. Bumpers can also be used along the sides;
- means to slow the AGV from full to crawl speed, should an obstacle be detected in its path (eg optical sensors);
- means to ensure accurate positioning of the AGV at transfer points;
- emergency stop buttons on the vehicle accessible from any side;
- automatic monitoring of the safety system. This includes automatic monitoring of the machine condition (eg brakes and sensors) so that the main computer can arrange to take suitable action (eg an emergency stop) should a system failure occur; and
- audible and visible signals to indicate that the vehicle is moving or about to move or that an obstacle has been detected.

Safeguarding at transfer points

676 In automated and semi-automated warehousing, the palletised load is transferred from the mechanical handling device to the automated storage and retrieval machine, usually via an opening in the perimeter fence surrounding the storage area. Risks may arise from contact with dangerous moving parts of the transfer mechanism, and access into the restricted area of the warehouse through large openings for feeding and delivery of pallets.

677 Dangerous moving parts of the transfer mechanism should be dealt with by, as far as possible, eliminating them by design, by providing close guarding (eg for chains and sprockets, vee belt drives) and by fixed or interlocked guards. The use of electro-sensitive safety systems, including pressure sensitive mats and photo-electric devices (see paragraphs 679–683), may be necessary either to supplement fixed or interlocked guarding, or instead of such guarding if it is not practicable. Access through the feed and delivery openings into the restricted area of the automated warehouse should be prevented by:

- restricting the size of the opening to the minimum possible, eg when trays of components are being fed into the system. This may present a simple and effective way of preventing access. Secondary traps between the load and sides of the fixed opening should, however, be avoided. It may be necessary to provide sensitive edges or trip flaps at the openings to prevent finger traps;
- if it is not possible to reduce the opening to the extent that a person is not able to climb through, other means will be required, eg a photo-electric safety device which causes a shutdown of the transfer system and those parts of the automated warehouse that would be accessible following access through the opening. This photo-electric system would be muted after positive identification of the presence of incoming or outgoing goods for a timed period to allow goods in/out. Means of identification include a combination of transponders, identification tags, pallet profile identification, patterns and sequences of tripping of photo-electric sensors, load sensors etc.

678 The objective should be to allow legitimate goods entry and egress, but to prevent inadvertent human access to an automated storage area when it is in operation.

Examples of safety systems

Electro-sensitive safety systems

679 These systems may be arranged to operate as trip devices, on the principle of detecting the approach of people, or as presence-sensing devices where dangerous parts cannot be set in motion when a person or object is detected.

Photo-electric (PE) safety systems

680 These systems detect an obstruction in the path by using a beam or beams of light (visible or invisible, eg infrared). Recommendations for the design and performance of high integrity PE safety systems are given in BS EN 61496.

681 PE safety systems may be used as:

- a trip device;
- a presence-sensing device; or
- a combination or zoning system where two or more PE devices are used as sensors and/or trip devices.

Pressure sensitive mats

682 These devices are placed on and secured to the horizontal surface over which a person may attempt to seek access. They have a sensitive upper surface so that the pressure applied by someone standing on them will cause dangerous motion to stop. See BS EN 1760.

683 When using electro-sensitive safety systems, PE safety systems, pressure sensitive mats or other suitable safeguards, the presence of a person or people in an identified and defined hazardous area should be detected and the appropriate action taken to remove or reduce the risk of injury, eg conveyor system stopped and approach to an active automated stacking machine prevented.

Safeguards for storage areas

Conventional perimeter fencing

684 Conventional perimeter fencing is made from rigid 2 m high fencing, securely fastened to the floor or to some convenient structure (eg racking) and positioned so that it is not possible to reach any dangerous parts of machinery or trapping points between automated stacking machines and fixed structures.

Access gates provided with interlocking device(s)

685 An example is a trapped key exchange, which positively isolates the power supply or the control to all or parts of the storage system. The essential elements are a lock on the perimeter fencing gate(s) and another lock on the control unit for the automated stacking machine. The key cannot be removed from the control unit to open the gate lock until a safe condition is established, eg isolation of the power supply to automated stacking machine.

Safe systems of work

686 You should establish a safe system of work, eg for routine maintenance work, access for statutory examination of plant and where the automated stacking machine is rider-operated. It is important that the design of the storage area allows safe systems of work to be adopted (hence the importance of detailed discussions between the supplier and user). If it is necessary to restore power to the system with someone inside the restricted area (eg for fault finding, fault recovery or maintenance), it should be possible for this to be done in safety:

- Restoring power to the system should be in the hands of the person within the restricted area (eg a key exchange system that allows them to restore power to a specific stacking machine).
- Operation of the stacking machine or other unit should be under the sole control of the person within the restricted area. There should be no other possibility of restoring automatic operation, and the stacking machine or other item of equipment should not respond to remote signals.
- All other equipment should remain isolated. Alternatively, if there are multiple bays and several stacking machines, there should be means of safely isolating the stacking machine in the bay being worked on to prevent transfer bogies or other machines moving into that bay and to prevent maintenance staff moving into operating areas. This should include software control features, hardware features and physical barriers.
- There should be a safe place or places of work for the person within the restricted area, eg areas around the subsidiary control panel (if any), working platform on the stacking machine etc.
- Access/egress routes to rider-operated stacking machines should be designed so that entry into other parts of the restricted area, eg aisles, is not possible. For example, the access gate cannot be opened until the stacking machine is stationary and in a precise location to allow safe access/egress. A safe system of work should comprise a carefully considered analysis of the hazards, taking into account all the modes of operation, and needs for access/approach, leading to a method of working which will ensure the safety of those engaged in the particular activity. For each activity involving access to automated storage areas, you should adopt a formal written safe system of work. In some situations (eg repair work) it may be necessary to introduce a formal permit-to-work system which should set out:
 - a clear handover procedure;
 - what work is to be done;
 - who is to carry it out and the equipment necessary for the task;
 - what safety precautions are to be taken; and
 - a clear hand-back procedure.

687 Provide effective means to prevent overrun in the horizontal and vertical directions of travel, and to ensure the stacking machine is correctly positioned for loading, unloading and stacking etc. An adequate combination of limit switches and position-sensing devices should be provided and clearly identified in maintenance manuals etc. As a final safeguard, buffers should be provided on track-mounted systems at the limits of horizontal travel.

Safeguards

688 The safeguards described in paragraph 686 should be adopted for rider-operated stacking machines. In particular, increased protection will be achieved if a two-handed 'hold-to-run' control is combined with a sensor fitted to the operator's seat such that the operator must be seated with both hands on the controls before the stacking machine can be operated.



Figure 52 Perimeter fencing

Clear warning notices

689 Clear, unambiguous warning notices should be prominently displayed at all access gates and strategic locations. Such notices may include:

- Restricted access. Authorised persons only.
- Authorised persons must have read and understood the written safe systems of work.
- Procedures specified in the safe system of work must be strictly adhered to.



Figure 53 Interlocked access



Figure 54 Rail-dependent storage and retrieval machine with operator cabin

Temperature-controlled storage

690 Temperature-controlled storage (TCS) operates across a wide temperature range. The main bands are +4/5 °C for chill and –20 °C to –30 °C for frozen, although these can vary depending on product requirements. The additional hazards associated with working in such environments are harshest in stores operating below 0 °C. Some hazards, however, such as condensation build-up, can be found in chill stores.

691 The hazards highlighted in this chapter are in addition to those identified for ambient warehouses in other chapters of this book. Indeed, in many instances, the harsh environment found in TCS exacerbates the safety implications and requires additional safeguards and training.

692 Hazards can also vary according to the type of TCS. This is caused by the temperature of the store and the size and type of operation undertaken, eg small freezer rooms, bulk stores, picking operations.

Specific hazards

693 Many hazards are specific to TCS and you should use physical precautions, safety equipment, operational and contingency plans and staff training:

- accidental lock-in;
- handling and accidental release of refrigerant;
- injury caused by a cold environment;
- effects on mobility caused by PPE;
- potential for increase in accidents;
- health risks;
- ice build-up;
- increased risk of equipment failure;
- building integrity and maintenance;
- powered mechanical doors.



Figure 55 Trapped man alarm

Risk control measures

694 It is of paramount importance in the temperature-controlled environment that all significant hazards are identified, the risk assessed and appropriate control measures put in place. This should also take account of specific legislation and guidance.

Accidental lock-in

695 This is potentially a serious hazard that can lead to fatal accidents, particularly in low temperature stores. At temperatures below -12°C , lone working should be avoided and a buddy system introduced.

696 Adequate emergency exits and signage are essential in TCS, together with highly visible escape routes. This can significantly reduce the danger of a lock-in. However, you should undertake an assessment to confirm there are adequate means of escape considering, for example, escape routes blocked by collapsed racking, fallen stock or other obstructions. Consider all potential means of communication, including lone worker/trapped-man alarms, mobile phones, radios, PA systems and computer links.

697 The following precautions are recommended to avoid accidental lock-in:

- Only authorised people should be allowed to enter the TCS. They should be fully instructed on the means of escape, the use of 'locked-door' opening devices and trapped-man alarms.
- Clear, conspicuous signs should be prominently displayed at the entrance door(s), indicating 'No unauthorised entry'.
- At least one emergency exit should be provided. You should, however, make an assessment as to whether additional emergency exits are required. Such exits should be suitably positioned with due regard to the operational layout, and should not be obstructed by racking, stock or equipment. They should be adequately signed with either emergency lighting or luminous signs located in such a position as not to be obstructed by racking, stock or equipment. Clear illuminated instructions on the method of escape should be marked on the emergency exit. Emergency exit doors should be capable of being opened from the inside at all times, and in sub-zero stores it is advisable to fit door strip heaters. It is recommended that all doors in TCS are capable of being opened from the inside, even when padlocked from the outside.
- Most TCS will have a range of communication methods available for workers to raise an alarm. Detailed plans should be in place to use these devices to alert a lock-in. As a minimum, a trapped-man alarm, mains operated with battery back-up, should be provided. The call point should be located no higher than 900 mm above the floor of the cold store and be suitably marked (illuminated or luminous sign) to indicate its position and function. The alarm note should be a distinctive sound, eg clearly distinguishable from the fire alarm and the sounding device should be located in an area that is normally manned. Additionally, where staff are working on their own (eg maintenance staff in remote and confined areas of the store), lone worker alarms incorporating movement detection are recommended, or a buddy system. For people working at temperatures below -12°C , lone working is not recommended and a buddy system should be adopted.
- Battery-operated emergency lighting (to BS 5266: Part 1) should be provided to clearly indicate the escape route(s).
- Trapped-man alarms, door-release devices and emergency exits should be properly maintained and regularly tested to ensure that they are in good working order.
- Before a TCS is locked, a thorough check should be made by an appointed member of staff to ensure that it is unoccupied.
- The fire authority should be contacted for advice regarding any arrangements or conditions that may be necessary to meet current fire safety standards.

Handling and accidental release of refrigerant

698 Ammonia and halocarbons are the main refrigerants used in cold store applications.

699 Equipment failure, improper maintenance work, mechanical damage or accidental release during refrigerant replenishment can all produce a potentially hazardous situation.

700 Probably the greatest hazard comes from the release of ammonia. This is a toxic and flammable gas and should be handled with extreme care. Small or minor leaks should be identified, isolated and neutralised. Larger leaks should be classed as major and dealt with according to the cold store's emergency procedures. Personnel should not attempt to correct a leak unless competent and authorised to do so, and only when wearing the correct PPE. The system should be designed to minimise the likelihood and consequence of accidental release of liquid ammonia during maintenance, eg when oil draining. In such circumstances, either a double valve arrangement (including a self-closing valve), or the use of a drain catch pot system, should be included in the system design.

701 Refrigerant handling and accidental release should be included in your COSHH assessments. Paragraphs 132–133 give more information on this.

702 Halocarbon refrigerants are of a lower toxicity but still pose a major risk, particularly in small confined environments such as plant rooms and small freezer rooms where displacement of oxygen can cause asphyxiation (suffocation). Even at low concentrations, halocarbons can cause health problems. If involved in a fire, these refrigerants produce toxic decomposition products. Suitable and adequate ventilation is required in all plant rooms to ensure workplace exposure limits are not exceeded.



Figure 56 An ammonia plant room emergency exit and alarm

703 Mechanical ventilation is required in plant rooms where group 2 and 3 refrigerants (see paragraph 704) are in use. The requirement for mechanical ventilation where group 1 (see paragraph 704) refrigerants are in use should be determined through competent risk assessment.

704 The following precautions should be taken against the accidental release of refrigerants:

- Refrigeration plant should be properly maintained and only operated and maintained by competent personnel who are properly trained, qualified and familiar with the specific refrigeration plant to be worked on. A plant diagram should be available and there should be proper labelling and identification of significant valves for isolation.
- A clear emergency procedure, including details of the precise duties of all relevant staff and the arrangements for evacuation, rescue, first aid, plant isolation etc, should be drawn up and effectively communicated to everyone likely to be affected in an emergency situation. This procedure should be periodically practiced and reviewed.
- Plant rooms should be provided with adequate and suitable ventilation including:
 - adequate ventilation to prevent build-up of toxic or dangerous concentrations of refrigerant from operational leakage. Mechanical ventilation should be provided in plant rooms where ammonia or halocarbons are the refrigerant in use. This should be discharged to a safe place in the open air;
 - emergency ventilation to prevent dangerous accumulations of a refrigerant (eg flammable ammonia vapour/air mixtures) in the event of a plant or operational failure;
 - refrigerant vapour detectors should be provided in plant rooms to activate an alarm should the workplace exposure limit be exceeded. Where mechanical ventilation is required for the plant room, the activation of this alarm should automatically switch on the ventilation fans.
- Group 1 refrigerants – non-flammable and non-toxic (eg CO₂, halocarbons): Where there is an exposure limit for refrigerants in this category, ventilation should be adequate and suitable to ensure the workplace exposure limits are not exceeded (see *Workplace exposure limits* EH40/2005).⁵³ Where natural ventilation is inadequate for this purpose, mechanical ventilation should be provided and should switch on if the concentrations exceed the workplace exposure limits. The decision on whether natural ventilation is adequate should be achieved through the process of risk assessment. This should be carried out by a competent person and it may also be appropriate to seek advice from a competent industry body.
- Group 2 refrigerants – ammonia: Ventilation fans should switch on if the concentration of refrigerant exceeds 1% by volume (V/V).
- Group 3 refrigerants – hydrocarbons: Ventilation fans should switch on if the concentration of refrigerant exceeds 25% of the lower explosive limit.
- In unmanned machinery rooms for group 2 and 3 refrigerants, the detector(s) should also isolate all zone 2/BS 5345 electrical circuits, other than emergency lighting and ventilation, by circuit breakers located in a safe place.
- The refrigerant concentration in each plant room should be monitored at one or more points within the room and detectors should be positioned to give warning of any leakage before a dangerous vapour accumulation can occur.
- The refrigerant detector, when sensing a refrigerant concentration exceeding its pre-set limit, should, in addition to its other functions, initiate an alarm in the plant room and elsewhere so that emergency action may be initiated.
- Emergency extraction fans installed in plant rooms should be of sufficient capacity to prevent any dangerous build-up of flammable concentrations.
- For minor maintenance work and for dealing with small leaks, a respirator with an appropriate filter may be suitable. However, where a high concentration of refrigerant is foreseeable, use self-contained breathing apparatus, along with other PPE as determined by risk assessment. Employees should receive suitable training in the use of this PPE. The risk assessment should also consider the provision of emergency rescue from areas affected by the release.
- A water shower is required to douse individuals who have been exposed to ammonia.

705 Refrigeration systems can be subject to the requirements of the Pressure Systems Safety Regulations 2000, which require a written scheme of examination and periodic examination by a competent person. However, it should be noted that vapour compression refrigeration systems, where the total installed power does not exceed 25 KW, are exempt from the Regulations.



Figure 57 Reach truck with cold store customisation

Injury caused by a cold environment

706 Freezing of the tissues results in frostnip or frostbite. Prolonged cold exposure, without freezing, may cause chilblains.

707 You should make special arrangements for the welfare of workers who are exposed to low temperatures for extended periods. These will include the provision of thermal protective clothing and warming rooms with drinks dispensers. Suitable and sufficient breaks should be arranged, based on a comprehensive risk assessment (guidance is in BS 7915:1998).

Lift trucks

708 The type of lift truck operated within a TCS will depend upon the nature of the operation. For example, where there is a high volume, full pallet operation, consider fitting lift trucks with heated cabs. Where the driver needs to get on and off the lift truck frequently, open-cab trucks may be more operationally practical. In these circumstances, you will need to consider, for example, providing appropriate PPE and facilities for taking additional breaks to warm up.

Personal protective equipment (PPE)

709 The nature of PPE required to protect workers in a TCS environment can have major effects on normal mobility, manual dexterity and visibility.

710 Suitable PPE should be provided and used in all instances. Selection of PPE should take account of the temperature, length of exposure, type of operation and personal preference. Different circumstances will apply, for example, to extended work periods inside the TCS, compared to intermittent or short-term exposure, and whether there is significant air movement within the store. Additional guidance on the selection of appropriate PPE can be obtained from the standards ISO 11079 and BS EN ISO 9920.



Figure 58 PPE to protect worker from cold temperature in cold store

711 When there is prolonged exposure to temperatures of $-20\text{ }^{\circ}\text{C}$ or below, it is advisable to avoid exposure of bare skin. When working in environments of $-40\text{ }^{\circ}\text{C}$, provide specialist respiratory protection and make sure goggles are worn. Also at $-40\text{ }^{\circ}\text{C}$, if there is any air movement, ensure that no work activity occurs, as the risks to health are too high.

Table 12 A guide to the recommended PPE to be worn in temperature-controlled storage facilities

Temperature range	Recommended PPE ensemble
Chill environment down to -5 °C	150 gm chill protective clothing including: <ul style="list-style-type: none"> • thermal undergarments to personal preference; • jacket and trousers or quilted all-in-one coverall; • lightweight gloves; • safety boots or shoes; and • head protection – baseball cap or thinsulate hat or safety helmet.
Frozen environment -5 °C and below	235 gm frozen protective clothing including: <ul style="list-style-type: none"> • thermal undergarments to personal preference; • jacket and salopettes or all-in-one coverall, both with knee protection; • cold-store gloves with thermal liners; • insulated safety boots with thermal socks; and • safety helmet with thermal liner, thermal balaclava and thermal hood.

The clothing weights given are a recommendation. The exact requirements should be determined by risk assessment

712 Examples of PPE are:

- thermal undergarments to personal preference;
- sock and/or boot liners;
- outer clothing – one-piece insulated suits, separate trousers and jackets or in some instances, thigh-length insulated coats;
- head covering, including balaclavas, insulated caps with ear muffs and insulated safety helmets;
- gloves and mittens with liners;
- insulated safety boots; and
- high-visibility vests should also be provided or, more effectively, high-visibility strips/panels should be incorporated into outer garments.

Layered clothing

713 Several thin layers of clothing provide better insulation than one thick layer, as working even moderately hard in a cold environment can quickly cause sweating due to the heat produced by the employee working and the clothing worn preventing evaporation of sweat from the skin's surface. When selecting cold-weather PPE, you need to consider how clothing can carry sweat away from the body when worn close to the skin, ie it should have good wicking properties. Polypropylene is more suitable than cotton, nylon is least suitable. If sweat wets the inside of clothing, when work stops that sweat will, as well as causing discomfort to the wearer, act as a refrigerant promoting heat loss from the body. Also, fabrics lose their insulating properties when wet. Cold-weather clothing, should therefore be designed to keep the inner garments dry, both from the inside and the outside.

Appropriate drying facilities

714 Provide adequate facilities for drying wet or damp PPE and clothing. Clothing should be laundered according to the manufacturer's instructions to ensure that it does not lose its thermal properties.

Selecting protective footwear

715 Selecting protective footwear requires careful consideration. In most situations, footwear may be needed that is both insulated against low temperature and resistant to impact. Standard safety footwear, with steel toecaps, may be unsuitable for extended exposure to lower temperatures. Safety footwear with high-

impact-resistant plastic toecaps, suitably insulated, may provide the degree of protection needed. Due to the potentially slippery nature of the environment, great care should be taken to select footwear with good anti-slip qualities. Information about suitable clothing for specific working conditions may be obtained from specialist manufacturers and suppliers of this equipment.

Hazards caused by PPE

716 Workers should be made aware of the additional hazards created by wearing PPE. These include:

- gloves can reduce dexterity and grip;
- footwear may reduce grip;
- ear-muffs and balaclavas can reduce hearing;
- balaclavas can reduce peripheral vision;
- glasses can be affected by condensation; and
- the physical bulk of PPE can reduce manoeuvrability and possibly restrict manual handling.

Selecting PPE

717 Table 12 is a guide to recommended PPE. The selection of suitable PPE should involve the process of risk assessment, taking into consideration temperature, length of exposure, type of operation and personal preference.

Potential for increased accidents

718 The very nature of TCS provides the potential for increased accidents. Ice, slippery surfaces, freezing surfaces (particularly metal) and condensation are a few examples of conditions that can increase the potential. Low temperatures may cause slower mental reactions and reduce dexterity skills, which may increase the risk of accidents. This is particularly the case with slips and trips and manual handling.

719 You should carry out thorough risk assessments and put in place safety precautions to minimise ice build-up and keep surfaces dry to prevent slips and skids.

720 In frozen environments particularly, ice build-up will be most prevalent between the loading bay area and the store. This is also probably the highest frequency movement area. As well as regular inspections, good maintenance and housekeeping and (where necessary) ice removal, consider the use of dehumidification systems. Such systems considerably reduce the level of water vapour in the atmosphere and, therefore, the opportunity for ice to build-up.

Health risks

721 Employers and employees need to be aware that if they are not adequately protected from the cold, there are potentially risks to health, eg hypothermia. You should also be aware that drugs may affect people's ability to regulate their body temperature in cold environments. Employees with certain medical conditions, such as asthma, angina and other cardiovascular diseases, Raynauds, hand-arm vibration syndrome, arthritis etc may be particularly at risk when working in low temperatures. Women can also be at risk, eg pregnant workers and their unborn children may be at risk.

722 People working in TCS should be physically fit for work and be free from any medical condition likely to be adversely affected by the low temperature. A pre-employment self-assessment medical questionnaire is recommended, followed by regular health surveillance. A minimum standard expected for the provision of health surveillance in these environments would be for an occupational health provider to be complying with BS EN ISO 12894:2001. Where there has been a change in a personal medical condition – through accident or illness – a review should be undertaken before work restarts.

723 Train your employees, including supervisors, to recognise the early symptoms of cold stress.

Ice build-up

724 Ice build-up may occur on the floor, above and around entrance doors, the ceiling and places where warm moist air enters the cold store. When doors are open, the moisture in the air quickly condenses and freezes onto the nearest cold surface. If not regularly removed, ice deposits can lead to serious accidents by falling onto workers below or causing floors to become uneven and slippery. Frozen spillages on the floor can present slip and trip hazards and skidding and overturning hazards where mechanical handling devices are used. It should also be noted that a build up of ice on ceiling panels can cause them to fall.



Figure 59 Fast-acting doorway

Increased risk of equipment failure

725 The TCS environment can have an adverse effect on equipment. Racking structures, lift trucks and other mechanical handling devices that operate permanently in the TCS may require more frequent inspection and maintenance. Careful selection of equipment should reduce this problem to a minimum.

726 The manufacturers of all equipment used at low temperatures, eg lift trucks and racking systems, should be consulted for advice on special hazards that may exist and the necessary precautions that may be required to reduce risks associated with use at low temperatures. In particular, the maintenance and immediate repair of damaged mobile racking is essential to avoid a possible major accident.

727 Condensation on the forks of lift trucks can cause pallet slippage, particularly where plastic pallets are in use. Wooden and metal pallets should also be regularly inspected for damage, as the environment can hasten deterioration through rotting and rust.

728 Finally, it is advisable for battery-powered handling equipment to be retained in the TCS environment at all times. This reduces condensation and ice build-up considerably, as well as prolonging battery life.

Building integrity and maintenance

729 Inadequate maintenance in a TCS can significantly increase accident risk. As well as the need to ensure equipment such as mechanical handling equipment (MHE) and racking is properly maintained, it is essential to pay attention to maintaining the fabric of the store structure. Breaches in insulation panels, the cores of which in many stores are flammable, can increase the fire risk. Ice build-up on ceiling panels can cause them to collapse or increase the risk of further hazardous ice build-up. Other aspects that you should consider include:

- Ensure electrical safety. As well as regular maintenance of electrical equipment, regular thermographic surveys are recommended to identify potential problem areas in the electrical system. Thermographic surveys can also identify breaches in the insulated envelope that result in increased energy consumption.
- Poor maintenance leads to ice build-up and the associated hazards described earlier. Dehumidification equipment at the main entrances to the TCS can help reduce ice build-up.
- The roof space should not be ignored as this area often contains a considerable amount of electrical equipment.
- If maintenance has to take place while a cold store is still operating at its designed temperature, any air movement caused by fans needs to be stopped during the maintenance period to minimise wind-chill effects.

Powered mechanical doors

730 Many TCS now have high-speed powered mechanical doors at the main entrances. Often these doors are operated by remote sensors. Pay attention to the MHE/personnel interface at door areas to reduce the potential for accidents. Examples of systems you can employ are:

- segregate MHE from workers by having separate doors for each;
- employ a traffic light system to prevent 'head-on' accidents;
- introduce a 'one-way' system. This can often be enforced by the doors only being able to be operated from one side. However, where this method is used, it is essential that there is an override to open the doors from either side in an emergency.

Keeping warm

731 Encourage your employees to follow this short and simple guide to keeping warm and safe in a TCS environment:

- **Choose clothes according to the job**, not only the temperature.
- **Avoid excessive sweating.** Reduce the numbers of layers you are wearing when highly active and add layers when you are less active. Also, when you are on your break, dry your clothes both inside and out.
- **Don't wear clothing that is too small or too tight**, as this restricts blood flow, preventing warm blood entering your extremities.
- **Drink lots of water;** cut down on tea and coffee, as they contain caffeine which acts as a diuretic and can dehydrate you. Instead, drink water, soup or hot chocolate.
- **Take care if you smoke or drink alcohol**, as these can affect the blood flow to your hands, arms, feet and legs. For example, alcohol dangerously affects the body's ability to regulate and conserve heat, while smoking can affect your circulatory system in the long term.
- **Consider your diet.** A healthy diet will provide your body with the necessary nutrients to function safely in the cold.
- **Protect bare skin.** Cover all areas that may become exposed to cold temperature or wind. Do not touch cold metal or plastic objects and surfaces with bare hands or skin.
- **Pay attention!** Cold hands and feet indicate a drop in body temperature. Get out of the cold if you experience extreme drowsiness, loss of balance, extreme shivering or slower than normal breathing, as these are early signs of hypothermia.
- **Always consider safety first** – the safety of you and your colleagues is paramount.

Storage of packaged dangerous substances

732 This section serves as a general overview of the storage of dangerous substances. Further detailed information can be found in *Chemical warehousing: The storage of packaged dangerous substances* HSG71.⁵⁴

733 The storage of packaged dangerous substances in substantial quantities may create serious risks, not only to people working at the warehouse but also to the general public and to the environment. The precautions needed to achieve a reasonable standard of control should take into account the properties of the substances to be stored, eg flammable, corrosive, and toxic. Different substances create very different risks and it is important that the standards adopted at the warehouse are based on an understanding of the physical and chemical properties of the substances concerned and the potential reactions between substances. Other important factors are the overall quantities of the substances to be stored and the maximum size of individual packages.

734 The incidents that cause the greatest concern are generally those that involve fire. Such fires expose employees, the emergency services, and members of the public to the threat of heat, harmful smoke and fumes, flying missiles etc. Fires can also cause the substances to be spread over a wider area through smoke and water used to fight the fire, thereby being harmful to the environment.

735 Common causes of these incidents include:

- lack of awareness of the chemical properties of substances;
- ignorance due to a lack of training;
- inappropriate storage conditions with regard to the substance hazards and substance reactions with other substances stored nearby;
- poor control over ignition sources, including those introduced by maintenance work;
- vandalism and arson;
- inadequate building design, equipment installation, maintenance; and
- exposure to heat from a nearby fire.

736 At all warehouses where packaged dangerous substances are to be stored, the employer should, before undertaking such storage, assess the risks created and the means adopted to control such risks. Your assessments should include:

- identification of substance(s) present or likely to be present;
- evaluation of risks posed by these substances;
- prevention and control of risk; and
- mitigation of risk.

737 It is recommended that the means adopted to control risks from the storage of dangerous packaged substances are written into your company safety policy. The risk assessment should be periodically reviewed and when the types of substance, total quantities or storage conditions change.

Identification and assessment

Information

738 The hazards of packaged dangerous substances should be identified by discussion and/or correspondence with the supplier before the substances are accepted for storage. Manufacturers and suppliers have a legal duty to provide adequate information about any risks to health or safety to which the inherent properties of a dangerous substance may give rise and about any conditions necessary to ensure that the substance will be safe and without risks to health when it is being used, handled, stored or transported.

739 Most dangerous substances arriving at the warehouse will be marked in accordance with the Carriage of Dangerous Goods and Use of Transportable Pressure Equipment Regulations 2004, which use the international United Nations labelling scheme. (See Appendix 2.)

Actions pre-arrival on-site of hazardous substances

740 Some substances will require special conditions for storage such as segregation, separation, not to be stored under sprinkler systems, store at a defined temperature range etc. These should be identified before the goods are accepted. The additional information obtained from the manufacturers and suppliers may identify specific examples of non-compatibility, and storage locations should take account of this. Substances requiring special conditions should only be accepted for storage when the required conditions can be made available, and maintained, at the warehouse.

741 Material safety data sheets (MSDS) are a prime source of information regarding storage requirements.

742 Producing a site layout plan of your storage area, which shows the areas where the different classifications of substances will be stored, is an effective way of helping to ensure that goods are stored in the correct areas. All relevant employees should be made fully aware of this plan.

Actions on arrival on-site of hazardous substances

743 On arrival, the contents of each consignment or individual package should be checked, identified and assessed against the shipment documents to verify acceptability. The goods should be checked to ensure they match the original agreed consignment as well as the lorry driver's delivery ticket. Dangerous substances should usually be identifiable by the transport labelling attached to the outer layer(s) of the packaging. It should be remembered that these labels and markings refer to the transport of dangerous goods and not to the storage considerations. Warning labels and information pertaining to the safe storage, handling and use of substances will be found on the MSDS and on the inner packages.

744 If the contents of any package are not immediately identifiable, it should not be sent to store. Such packages should be held in quarantine and only for the minimum time necessary to obtain information, or the supplier should be required to have them removed from the site promptly.

745 Once the storage location for a consignment has been allocated, and before the materials are put into the store, a physical check should be made to confirm that adjacent materials are those shown on stock records. This is to ensure that the materials are compatible for storage and will not adversely react if exposed to one another. If all or part of a consignment is moved during its period of storage, the check procedures should be repeated to ensure that the new storage location will still be valid. (See paragraphs 747–748 on *Segregation*.)



Figure 60 Workplace information on the storage of hazardous substances

Risk prevention and control strategy

Package integrity

746 The primary protection against the dangers arising from storing dangerous substances is the integrity of the packaging. Individual containers may leak, break or be punctured, causing a small escape of material, and you should have arrangements in place to deal with this eventuality (see paragraphs 758–763 on *Spillages*.) Much greater risks arise where a large number of containers fail in a short time, and the principal means by which this may occur is fire.

Segregation

747 Often the first material ignited in a fire is not itself a dangerous substance. For this reason, stocks of combustible materials, such as easily ignitable packaging, should not be kept in storage areas with dangerous substances. Separate storage areas should be provided. Similarly, even small quantities of dangerous substances stored in a warehouse for general goods may seriously increase the consequences of any fire, and add to the dangers for the fire brigade. Dangerous substances should preferably be stored in dedicated compartments of the warehouse, which are effectively fire-separated from the rest of the building.

748 The intensity of a fire, or its rate of growth, may be increased if incompatible materials are stored together. In addition, a fire may grow and involve dangerous substances which of themselves are not combustible. As a result of fire, toxic materials may be widely dispersed, either due to the nature of the individual substances, the mixture of unconfined substances, or as a result of incomplete combustion. To prevent this type of escalation, or adverse reactions, a system of segregation is necessary in a warehouse storing dangerous substances.

Ignition sources

749 All possible sources of ignition (eg smoking, maintenance work, electrical power supplies, arson, heating systems, warehouse vehicles and battery charging facilities etc) should be strictly controlled to reduce the risks to an acceptable level.

Handling

750 All packages containing dangerous substances should be handled carefully to avoid damage to the containers, or spillage of the contents. Damaged or leaking containers should not be placed in store, but should be repacked or disposed of safely in accordance with arrangements made with, or information provided by, the supplier. The requirements of Hazardous Waste Regulations should also be met when disposing of damaged packages. Repacking should be carried out in an area remote from the main storage areas and following risk assessment.

751 Leaking containers should be placed in, or on, a suitable bund or tray to enable any leaking product to be captured while awaiting repacking or disposal.

Stock control

752 Storerooms and compounds should not be overstocked, and permanent instructions should specify a maximum storage capacity for each location. Gangways should be kept clear of obstructions, especially those designated as means of escape. At least 1 m of clear space should be left between all stock tops and the warehouse roof, roof beams or light fittings. Where sprinklers are fitted, spacing should be in accordance with the design code for the system. This information should be available from the system installers. Care should be taken with stores fitted with sprinkler systems as some products should not be stored in such areas. This information will be included on the MSDS.

753 Where a number of different types of dangerous substance are stored, a comprehensive record of stocks, providing details of the quantity, nature and exact location of all dangerous substances in a store, should be made and carefully updated each time a stock movement occurs. Keep a copy of the records available at a point on the site that is unlikely to be affected in an emergency, so that they can be used by both management and the emergency services when dealing with an incident.

754 The Control of Major Accident Hazards Regulations 1999 (as amended) (COMAH) require special actions to be taken if it is anticipated that defined quantities of hazardous substances will be held on site (see paragraphs 768–772).

Storage stability

755 Some types of substances may degrade or become unstable during prolonged storage or if stored at incorrect temperatures. These substances should be identified by information from the supplier, manufacturer or MSDS. Maximum recommended storage times should not be exceeded and this should be achieved by careful stock rotation. The advice of the supplier should be sought if material is found which has reached, or is about to reach, the recommended latest storage date.

756 Any stock held for a prolonged period should be inspected at intervals to detect any damaged or degrading packaging. Records of inspections should be maintained.

757 Temperature ranges should be carefully managed to ensure that ambient temperatures in the defined storage area do not fall below or exceed the specified range. You should have an escalation procedure in place to provide guidance should this situation occur. The supplier or manufacturer can provide this guidance.



Figures 61 and 62 Parts of a sprinkler system

Figure 63 Segregation table

	CLASS	CLASS	CLASS	CLASS	CLASS	CLASS	CLASS	CLASS	CLASS
Compressed gases	2.1 Flammable								
	2.2 Non-flammable/non-toxic								
	2.3 Toxic								
Flammable liquids									
	Flammable solids	4.1 Readily combustible							
		4.2 Spontaneously combustible							
4.3 Dangerous when wet									
Oxidising substances	5.1 Oxidising substances								
	5.2 Organic peroxides								
	Toxic substances								
Corrosive substances									

Segregate from These combinations should not be kept in the same building compartment or outdoor storage compound. Compartment walls should be impermeable, of at least 30 minutes fire resistance and sufficiently durable to withstand normal wear and tear. Brick or concrete construction is recommended. An alternative is to provide separate outdoor storage compounds with an adequate space between them.

Separation may not be necessary, but consult suppliers about requirements for individual substances. In particular, note that some types of chemicals within the same class, particularly Class 8 corrosives, may react violently, generate a lot of heat if mixed or evolve toxic fumes.

ISOLATE This is used for organic peroxides, for which dedicated buildings are recommended. Alternatively, some peroxides may be stored outside in fire-resisting secure cabinets. In either case, adequate separation from other buildings and boundaries is required.

KEEP APART Separate packages by at least 3 m or one gangway width, whichever is the greater distance, in the storeroom or storage area outdoors. Materials in non-combustible packaging that are not dangerous substances and that present a low fire hazard may be stored in the separation area. This standard of separation should be regarded as a minimum between substances known to react together readily, if that reaction would increase the danger of an escalating incident.

Segregate from The lower standard refers to the outside storage of gas cylinders. Where non-liquefied flammable gases are concerned, the 3 m separation distance may be reduced to 1 m.

Segregate from Where a particular material has the properties of more than one class, the classification giving the more onerous segregation should be used.

Spillages

758 You should ensure that there is a safe system of work to deal with spillages. When dealing with spillages, all non-essential or untrained staff should be evacuated from the danger area.

759 Provide sufficient equipment at strategic locations to enable trained personnel to manage foreseeable spillage incidents. Highlight the risk of incidents during risk assessment, along with any control measures required.

Liquid spillages

760 Where liquids are stored, provide methods for containing spillage. Barrier materials such as sand bags or proprietary absorbent pads/socks/granules are recommended, depending on the nature of the substance and the quantities involved. The chosen absorbent should not adversely react with the substance to be absorbed – this information would be found on the MSDS in the *Spillage* section.

Solid spillages

761 Spillages of dangerous substances in a fine dusty form should not be cleared up by dry brushing. Vacuum cleaners should be used in preference, or damp sweeping, and for toxic materials, a vacuum cleaner conforming to type H of BS 5415 should be used.

Personal protection

762 Personal protective equipment will be necessary for dealing with accidental releases of dangerous substances. Protective footwear, gloves and eye protection are likely to be the minimum requirements. In some cases, additional items will be needed, eg respiratory protective equipment. The MSDS will provide guidance on both the equipment and levels of protection required for a given substance.

763 When corrosive materials have been spilled, take care to ensure that people dealing with the spillage wear clothing with the necessary protection. Clothing contaminated with any dangerous substance should be removed immediately. Spare overalls should be available on site. Contaminated clothing should not be sent with other general laundry, nor taken home. It may be cleaned by arrangement with a specialist laundry, or disposed of as hazardous waste.



Figure 64 Spill kit

Warning signs

764 Post warning notices or signs at entrances to a warehouse storing dangerous substances. Where 25 tonnes or more of dangerous substances are stored, the Dangerous Substances (Notification and Marking of Sites) Regulations 1990 make specific requirements for posting hazard warning signs and the design of signs used. The fire brigade should be consulted about requirements for the siting of signs.

Management and training

765 You should appoint a senior member of staff to be directly responsible for the identification, assessment, handling and safe storage of all dangerous substances on site. The appointed person should have suitable qualifications, training and experience and be familiar with the legislation relevant to the activities undertaken. Written operating procedures should be adopted covering matters such as selection of storage locations, dealing with spillages and security arrangements.

766 Employees should be trained to recognise and understand the risks associated with the particular classes of dangerous substances that will be kept in the warehouse. They should be shown how to understand the system of labelling adopted under the Chemicals (Hazard Information and Packaging for Supply) Regulations 2002 (CHIP)⁵⁵ and the Carriage of Dangerous Goods and Use of Transportable Pressure Equipment Regulations 2004. They should also be told where particular substances should be stored and why, and should be made familiar with the precautions and safety procedures adopted by the warehouse.

767 Instructions for dealing with an emergency should include the steps necessary to enable staff to easily identify and deal with damaged and/or leaking packages and containers. Training should be given in the use of safety and spill control equipment provided and in the actions to be taken in the event of fire, spillage etc identified during risk assessment.

Special regulations

Control of Major Accident Hazards Regulations 1999 (COMAH) (as amended)

768 There are specific requirements for the small number of warehouses storing dangerous substances on a sufficient scale to exceed the threshold quantities determining application of the lower tier (LT) or top tier (TT) of the COMAH Regulations. For top tier sites, a safety report will have to be prepared and submitted to the competent authority (HSE and the Environment Agency/Scottish Environment Protection Agency) via the HSE area office. The report must demonstrate that the company has taken all measures necessary to prevent major accidents and limit the consequences to people/the environment if an incident should occur. On-site emergency plans will have to be prepared and technical information supplied to the local authority emergency planning officer so that an off-site plan can be prepared. Information will also have to be supplied to the public, who might be affected by a major accident, about the nature of the hazards and the behaviour they should adopt in the event of a major accident.

769 Storage that would cause top tier COMAH to apply must not commence until the storage operator has received the conclusions of the examination of the safety report from the competent authority. Extensions of the scope of storage beyond the limits set in the safety report should be similarly preceded by a revised report. Full details of the requirements and the scope of application are contained in *A guide to the Control of Major Accident Hazards Regulations 1999 (as amended). Guidance on Regulations L111*.⁵⁶

770 Where the lower tier quantities are reached, these trigger the requirement to apply for and obtain permission (known as 'hazardous substance consent') to store from the local authority. No quantities exceeding these levels can be stored until this permission is granted. (Although note that if you are storing COMAH substances above lower tier threshold levels you will need hazardous substances consent, but not all substances you need consent for are COMAH substances.) It is the local authority who issues these consents. If you want to store dangerous substances on a site, you must have hazardous substances consent regardless of whether your safety report has been assessed.

Pesticide storage

771 The Control of Pesticides Regulations 1986 require pesticides to be approved before they may be advertised, sold, supplied or stored. In addition, at sites storing more than 200 kg or 200 litres of a pesticide approved for agricultural use, the pesticide must be stored under the control of a person holding a recognised Certificate of Competence. The Department for Environment, Food and Rural Affairs (Defra) code of practice (commonly known as the Yellow Book)⁵⁷ for suppliers of pesticides to agriculture, horticulture and forestry sets out the standards required.

772 From 1 April 1992, local authorities have enforced the Control of Pesticides Regulations in warehouses where the local authority is the enforcing authority.

Appendices

Appendix 1:

Warehousing Health and Safety Forum membership













The Health and Safety Executive (HSE) has written the second edition of this guidance book in liaison with the Warehousing Health and Safety Forum. The Warehousing Health and Safety Forum is a joint committee with representation from the following organisations:

- AMICUS the Union
- Association of Industrial Truck Trainers (AITT)
- Automotive Distribution Federation (ADF)
- Automated Material Handling Systems Association (AMHSA)
- British Frozen Food Federation (BFFF)
- British Industrial Truck Association (BITA)
- British Materials Handling Federation
- British Retail Consortium (BRC)
- Cold Storage and Distribution Federation (CSDF)
- Fork Lift Truck Association (FLTA)
- Freight Transport Association (FTA)
- Health and Safety Executive (HSE)
- Institution of Occupational Safety and Health (IOSH)
- Local Authorities Coordinators of Regulatory Services (LACORS)
- London Borough of Barking and Dagenham
- Skills for Logistics
- Storage Equipment Manufacturers' Association (SEMA)
- Textiles Industry Advisory Committee (TEXIAC)
- Transport and General Workers Union (TGWU)
- Union of Shop, Distributive and Allied Workers (USDAW)
- United Kingdom Warehousing Association (UKWA)
- GMB

Appendix 2:

Transport hazard diamond

(see Figure 63)

Classification	Hazard warning sign
Class 1	Explosive substances 
Class 2.1	Flammable gas 
Class 2.2	Non-flammable compressed gas 
Class 2.3	Toxic gas 
Class 3	Flammable liquid 
Class 4.1	Flammable solid 
Class 4.2	Spontaneously combustible substance 
Class 4.3	A substance which in contact with water emits flammable gas 
Class 5.1	Oxidising substance 
Class 5.2	Organic peroxide *permissible until 2010 
Class 6.1	Toxic substance 
Class 8	Corrosive substance 
Class 9	Other dangerous substance 

Appendix 3:

Examples of common types of trucks



Figure 1 Pedestrian operated counterbalanced fork-lift truck



Figure 2 High-lift platform truck



Figure 3 Pedestrian operated pallet stacker



Figure 4 Straddle pallet stacker



Figure 5 Stand-on reach truck



Figure 6 Medium-lift order picking truck



Figure 7 High-lift order picking truck



Figure 8 Very narrow aisle lateral and front stacking truck – man up



Figure 9 Very narrow aisle lateral and front stacking truck – man down



Figure 10 Pivot steer truck



Figure 11 Bi- and multi-directional truck



Figure 12 Rider operated low-level order picking truck



Figure 13 Pedestrian powered/controlled pallet truck



Figure 14 Tow tractor

Note: some of these types of trucks have different operator positions. These figures give an example of one type of operator position for each truck.

References

- 1 *Management of health and safety at work. Management of Health and Safety at Work Regulations 1999. Approved Code of Practice and guidance L21* (Second edition) HSE Books 2000 ISBN 978 0 7176 2488 1
- 2 *Successful health and safety management HSG65* (Second edition) HSE Books 1997 ISBN 978 0 7176 1276 5
- 3 *Five steps to risk assessment* Leaflet INDG163(rev2) HSE Books 2006 (single copy free or priced packs of 10 ISBN 978 0 7176 6189 3)
Web version: www.hse.gov.uk/pubns/indg163.pdf
- 4 *Investigating accidents and incidents: A workbook for employers, unions, safety representatives and safety professionals HSG245* HSE Books 2004 ISBN 978 0 7176 2827 8
- 5 *A guide for new and expectant mothers who work* Leaflet INDG373 HSE Books 2003 (single copy free or priced packs of 10 ISBN 978 0 7176 2614 4)
Web version: www.hse.gov.uk/pubns/indg373.pdf
- 6 *Working together: Guidance on health and safety for contractors and suppliers* Leaflet INDG268(rev1) HSE Books 2002
Web version: www.hse.gov.uk/pubns/indg268.pdf
- 7 *Consulting employees on health and safety: A guide to the law* Leaflet INDG232 HSE Books 1996 (single copy free or priced packs of 15 ISBN 978 0 7176 1615 2) Web version: hse.gov.uk/pubns/indg232.pdf
- 8 *The law on VDUs: An easy guide: Making sure your office complies with the Health and Safety (Display Screen Equipment) Regulations 1992 (as amended in 2002)* HSG90 HSE Books 2003 ISBN 978 0 7176 2602 1
- 9 *Real solutions, real people: A managers' guide to tackling work-related stress* HSE Books 2003 ISBN 978 0 7176 2767 7
- 10 *Working together to reduce stress at work: A guide for employees* Leaflet MISC686 International Stress Management Association 2005 (single copy free or priced packs of 15 ISBN 978 0 7176 6122 0)
- 11 *Managing shift work: Health and safety guidance HSG256* HSE Books 2006 ISBN 978 0 7176 6197 8
- 12 *Noise at work: Guidance for employers on the Control of Noise at Work Regulations 2005* Leaflet INDG362(rev1) HSE Books 2005 (single copy free or priced packs of 10 ISBN 978 0 7176 6165 7)
Web version: www.hse.gov.uk/pubns/indg362.pdf
- 13 *COSHH essentials: Easy steps to control chemicals. Control of Substances Hazardous to Health Regulations HSG193* (Second edition) HSE Books 2003 ISBN 978 0 7176 2737 0
- 14 *COSHH: A brief guide to the Regulations: What you need to know about the Control of Substances Hazardous to Health Regulations 2002 (COSHH)* Leaflet INDG136(rev3) HSE 2005 Web only: www.hse.gov.uk/pubns/indg136.pdf

- 15 *Control the risks from hand-arm vibration: Advice for employers on the Control of Vibration at Work Regulations 2005* Leaflet INDG175(rev2) HSE Books 2005 (single copy free or priced packs of 10 ISBN 978 0 7176 6117 6)
Web version: www.hse.gov.uk/pubns/indg175.pdf
- 16 *Control back-pain risks from whole-body vibration: Advice for employers on the Control of Vibration at Work Regulations 2005* Leaflet INDG242(rev1) HSE Books 2005 (single copy free or priced packs of 10 ISBN 978 0 7176 6119 0)
Web version: www.hse.gov.uk/pubns/indg242.pdf
- 17 *Managing sickness absence and return to work: An employer's and manager's guide* HSG249 HSE Books 2004 ISBN 978 0 7176 2882 7
- 18 *Managing sickness absence and return to work in small businesses* Leaflet INDG399 HSE Books 2004 (single copy free or priced packs of 20 ISBN 978 0 7176 2914 5) Web version: www.hse.gov.uk/pubns/indg399.pdf
- 19 *Fire Safety Risk Assessment - Factories and warehouses* Department for Communities and Local Government ISBN 978 1 85112 816 7 (free download from www.firesafetyguides.communities.gov.uk)
- 20 *Lighting at work* HSG38 (Second edition) HSE Books 1997 ISBN 978 0 7176 1232 1
- 21 *Workplace health, safety and welfare. Workplace (Health, Safety and Welfare) Regulations 1992. Approved Code of Practice L24* HSE Books 1992 ISBN 978 0 7176 0413 5
- 22 *Slips and trips: Guidance for employers on identifying hazards and controlling risks* HSG155 HSE Books 1996 ISBN 978 0 7176 1145 4
- 23 *Preventing slips and trips at work* Leaflet INDG225(rev1) HSE Books 2003 (single copy free or priced packs of 15 ISBN 978 0 7176 2760 8) Web version: www.hse.gov.uk/pubns/indg225.pdf
- 24 *Memorandum of guidance on the Electricity at Work Regulations 1989. Guidance on Regulations* (Second edition) HSR25 HSE Books 2007 ISBN 978 0 7176 6228 9
- 25 *Maintaining portable and transportable electrical equipment* (Second edition) HSG107 HSE Books 2004 ISBN 978 0 7176 2805 6
- 26 *Code of Practice for In-service Inspection and Testing of Electrical Equipment* IEE 2001 ISBN 978 0 85296 776 4
- 27 *First aid at work. The Health and Safety (First Aid) Regulations 1981. Approved Code of Practice and guidance* L74 HSE Books 1997 ISBN 978 0 7176 1050 1
- 28 *A guide to the Reporting of Injuries, Diseases and Dangerous Occurrences Regulations 1995* L73 (Second edition) HSE Books 1999 ISBN 978 0 7176 2431 7
- 29 *RIDDOR explained: Reporting of Injuries, Diseases and Dangerous Occurrences Regulations* Leaflet HSE31(rev1) HSE Books 1999 (single copy free or priced packs of 10 ISBN 978 0 7176 2441 6)

- 30 *Getting to grips with manual handling: A short guide* Leaflet INDG143(rev2) HSE Books 2004 (single copy free or priced packs of 15 ISBN 978 0 7176 2828 5) Web version: www.hse.gov.uk/pubns/indg143.pdf
- 31 *Manual handling: Solutions you can handle* HSG115 HSE Books 1994 ISBN 978 0 7176 0693 1
- 32 *Manual handling. Manual Handling Operations Regulations 1992 (as amended). Guidance on Regulations L23* (Third edition) HSE Books 2004 ISBN 978 0 7176 2823 0
- 33 *Upper limb disorders in the workplace* HSG60 (Second edition) HSE Books 2002 ISBN 978 0 7176 1978 8
- 34 *Fitting and use of restraining systems on lift trucks* Information Sheet MISC241 HSE Books 2000 Web version: www.hse.gov.uk/pubns/misc241.pdf
- 35 *Working platforms (non-integrated) on fork-lift trucks* PM28 (Third edition) HSE 2005 Web only: www.hse.gov.uk/workplacetransport/pm28.pdf
- 36 *Safety in working with lift trucks* HSG6 (Third edition) HSE Books 2000 ISBN 978 0 7176 1781 4
- 37 *Operator safety – Daily checks* 0703 FLTA
- 38 *Thorough examination and safety inspections of industrial lift trucks* Guidance note GN28 BITA www.bita.org.uk
- 39 *Rider-operated lift trucks. Operator training. Approved Code of Practice and guidance* L117 HSE Books 1999 ISBN 978 0 7176 2455 3
- 40 *Driving at work: Managing work-related road safety* Leaflet INDG382 HSE Books 2003 (single copy free or priced packs of 4 ISBN 978 0 7176 2740 0) Web version: www.hse.gov.uk/pubns/indg382.pdf
- 41 *Workplace transport safety: An employers' guide* HSG136 (Second edition) HSE Books 2005 ISBN 978 0 7176 6154 1
- 42 *Coupling or uncoupling and parking of large goods vehicle trailers* SOE/IRTE www.soe.org.uk
- 43 *Safety of loads on vehicles* Code of Practice DfT 2002 ISBN 978 0 11 552547 5
- 44 *Tail lift specification guide for road vehicles* SOE/IRTE 2005 www.soe.org.uk
- 45 *The Work at Height Regulations 2005 (as amended): A brief guide* Leaflet INDG401(rev1) HSE Books 2007 (single copy free or priced packs of 10 ISBN 978 0 7176 6231 9) Web version: www.hse.gov.uk/pubns/indg401.pdf
- 46 *Safe use of ladders and stepladders: An employers' guide* Leaflet INDG402 HSE Books 2005 (single copy free or priced packs of 5 ISBN 978 0 7176 6105 3) Web version: www.hse.gov.uk/pubns/indg402.pdf
- 47 *Safety in the storage and handling of steel and other metal stock* HSG246 HSE Books 2004 ISBN 978 0 7176 1986 3

- 48 *Industrial robot safety: Your guide to the safeguarding of industrial robots* HSG43 (Second edition) HSE Books 2000 ISBN 978 0 7176 1310 6
- 49 *Terms and descriptions of storage equipment* SEMA www.sema.org.uk
- 50 *Load notices* SEMA www.sema.org.uk
- 51 *Recommended practices for safe use of static pallet racking* SEMA www.sema.org.uk
- 52 *Guide to the conduct of pallet racking and shelving surveys* SEMA www.sema.org.uk
- 53 *EH40/2005 Workplace exposure limits: Containing the list of workplace exposure limits for use with the Control of Substances Hazardous to Health Regulations 2002 (as amended)* Environmental Hygiene Guidance Note EH40 HSE Books 2005 ISBN 978 0 7176 2977 0
- 54 *Chemical warehousing: The storage of packaged dangerous substances* HSG71 (Second edition) HSE Books 1998 ISBN 978 0 7176 1484 4
- 55 *The idiot's guide to CHIP 3: Chemicals (Hazard Information and Packaging for Supply) Regulations 2002* Leaflet INDG350 HSE Books 2002 (single copy free or priced packs of 5 ISBN 978 0 7176 2333 4) Web version: www.hse.gov.uk/pubns/indg350.pdf
- 56 *A guide to the Control of Major Accident Hazards Regulations 1999 (as amended). Guidance on Regulations* L111 HSE Books 2006 ISBN 978 0 7176 6175 6
- 57 'Yellow Book' Code of Practice DEFRA

Further reading

Warehousing and storage: Top health and safety tips Leaflet INDG412 HSE Books 2007 (single copy free or priced packs of 15 ISBN 978 0 7176 6253 1) Web version: www.hse.gov.uk/pubns/indg412.pdf

Electrical safety and you Leaflet INDG231 HSE Books 1996 (single copy free or priced packs of 15 ISBN 978 0 7176 1207 9) Web version: www.hse.gov.uk/pubns/indg231.pdf

Electricity at work: Safe working practices HSG85 (Second edition) HSE Books 2003 ISBN 978 0 7176 2164 4

Electrical risks from steam/water pressure cleaners Plant and Machinery Guidance Note PM29 (Second edition) HSE Books 1995 ISBN 978 0 7176 0813 3

Do you use a steam/water pressure cleaner? You could be in for a shock! Leaflet INDG68(rev) HSE Books 1997 (single copy free) Web version: www.hse.gov.uk/pubns/indg68.pdf

Using electric storage batteries safely Leaflet INDG139(rev1) HSE Books 2006 (single copy free) Web version: www.hse.gov.uk/pubns/indg139.htm

Basic advice on first aid at work Leaflet INDG347(rev1) HSE Books 2006 (single copy free or priced packs of 20 ISBN 978 0 7176 6193 0) Web version: www.hse.gov.uk/pubns/indg347.pdf

First aid at work: Your questions answered Leaflet INDG214 HSE Books 1997 (single copy free or priced packs of 15 ISBN 0 7176 1074 8) Web version: www.hse.gov.uk/pubns/indg214.pdf

Managing health and safety: Five steps to success Leaflet INDG275 HSE Books 1998 (single copy free or priced packs of 10 ISBN 978 0 7176 2170 5) Web version: www.hse.gov.uk/pubns/indg275.pdf

Respiratory protective equipment at work: A practical guide HSG53 (Third edition) HSE Books 2005 ISBN 978 0 7176 2904 6

Aching arms (or RSI) in small businesses: Is ill health due to upper limb disorders a problem in your workplace? Leaflet INDG171(rev1) HSE Books 2003 (single copy free or priced packs of 15 ISBN 978 0 7176 2600 7) Web version: www.hse.gov.uk/pubns/indg171.pdf

Maintenance, examination and testing of local exhaust ventilation HSG54 (Second edition) HSE Books 1998 ISBN 978 0 7176 1485 1

Roll cages and wheeled racks in the food and drink industries: Reducing manual handling injuries Food Information Sheet FIS33 HSE Books 2003 Web version: www.hse.gov.uk/pubns/fis33.pdf

Industrial trucks on public roads GN57 BITA www.bita.org.uk

Useful websites

HSE website www.hse.gov.uk

Asbestos: www.hse.gov.uk/asbestos

COSHH: www.hse.gov.uk/coshh

Managing sickness absence and return to work:
www.hse.gov.uk/sicknessabsence

Musculoskeletal disorders, and the Manual Handling Assessment Chart (MAC Tool):
www.hse.gov.uk/msd

Preventing slips and trips in the workplace, including the Slip Assessment Tool for assessing flooring performance: www.hse.gov.uk/slips

Risk management: www.hse.gov.uk/risk

Temperature and thermal comfort – working in hot and cold environments:
www.hse.gov.uk/temperature

Vehicles at work: www.hse.gov.uk/workplacetransport

Work-related stress: www.hse.gov.uk/stress

Young people at work: www.hse.gov.uk/youngpeople

Other websites

The Department of Trade and Industry's information on agency workers' health and safety: www.businesslink.gov.uk/agencyworkers

The Data Protection Code of Practice, published by the Information Commissioner – *Employment Practices Data Protection Code: Part 4 Information about Workers Health*: www.ico.gov.uk

Health surveillance – research by the International Labour Organization. Study on workers' 'barefoot research': www.ilo.org

Occupational safety and health advice services:

Workplace Health Connect in England and Wales:

www.workplacehealthconnect.co.uk

Safe and Healthy Working in Scotland:

www.safeandhealthyworking.com

The Storage Equipment Manufacturers' Association: www.sema.org.uk

British, European and international standards

BS EN 378-3:2000 *Specification for refrigerating systems and heat pumps. Safety and environmental requirements. Installation site and personal protection* British Standards Institution

BS EN 418:1992 *Safety of machinery. Emergency stop equipment, functional aspects. Principles for design* British Standards Institution

BS EN 528:2006 *Rail dependent storage and retrieval equipment. Safety* British Standards Institution

BS EN 619:2002 *Continuous handling equipment and systems. Safety and EMC requirements for equipment for mechanical handling of unit loads* British Standards Institution

BS EN 953:1998 *Safety of machinery. Guards. General requirements for the design and construction of fixed and movable guards* British Standards Institution

BS EN 1088:1996 *Safety of machinery. Interlocking devices associated with guards. Principles for design and selection* British Standards Institution

BS EN 1726-1:1999 *Safety of industrial trucks. Self propelled trucks up to and including 10 000 kg capacity and industrial tractors with drawbar pull up to and including 20 000 N. General requirements* British Standards Institution

BS EN 1726-2:2000 *Safety of industrial trucks. Self-propelled trucks up to and including 10 000 kg capacity and tractors with a drawbar pull up to and including 20 000 N. Additional requirements for trucks with elevating operator position and trucks specifically designed to travel with elevated loads* British Standards Institution

BS EN 1756-1:2001 *Tail lifts. Platform lifts for mounting on wheeled vehicles. Safety requirements. Tail lifts for goods* British Standards Institution

BS EN 1756-2:2004 *Tail lifts. Platform lifts for mounting on wheeled vehicles. Safety requirements. Tail lifts for passengers* British Standards Institution

BS EN 1760-1:1998 *Safety of machinery. Pressure sensitive protective devices. General principles for the design and testing of pressure sensitive mats and pressure sensitive floors* British Standards Institution

BS EN 1760-2:2001 *Safety of machinery. Pressure sensitive protective devices. General principles for the design and testing of pressure sensitive edges and pressure sensitive bars* British Standards Institution

BS EN 1760-3:2004 *Safety of machinery. Pressure sensitive protective devices. General principles for the design and testing of pressure sensitive bumpers, plates, wires and similar devices* British Standards Institution

BS 5266-1:2005 *Emergency lighting. Code of practice for the emergency lighting of premises* British Standards Institution

PD 5302:2005 *Guidance on safe use of machinery* British Standards Institution

BS 5345: *Code of practice for the selection, installation and maintenance of electrical apparatus for use in potentially explosive atmospheres (other than mining applications or explosive processing and manufacture)* British Standards Institution

BS 5415: *Safety of electrical motor-operated industrial and commercial cleaning appliances* British Standards Institution

BS 5499-5:2002 *Graphical symbols and signs. Safety signs, including fire safety signs. Signs with specific safety meanings* British Standards Institution

BS 6491: *Electro-sensitive safety systems for industrial machines* British Standards Institution

BS ISO 6780:1988 *General-purpose flat pallets for through transit of goods. Principal dimensions and tolerances* British Standards Institution

BS 7671:2001 *Requirements for electrical installations. IEE Wiring Regulations. Sixteenth edition* Institution of Electrical Engineers

BS 7915:1998 *Ergonomics of the thermal environment. Guide to design and evaluation of working practices for cold indoor environments* British Standards Institution

BS EN ISO 9920:2003 *Ergonomics of the thermal environment. Estimation of the thermal insulation and evaporative resistance of a clothing ensemble* British Standards Institution

DD ENV ISO 11079:1999 *Evaluation of cold environments. Determination of required clothing insulation* British Standards Institution

BS EN ISO 11202:1996 *Acoustics. Noise emitted by machinery and equipment. Measurement of emission sound pressure levels at a work station and at other specified positions. Survey method in situ* British Standards Institution

BS EN ISO 12100-1:2003 *Safety of machinery. Basic concepts, general principles for design. Basic terminology, methodology* British Standards Institution

BS EN ISO 12100-2:2003 *Safety of machinery. Basic concepts, general principles for design. Technical principles* British Standards Institution

BS EN ISO 12894:2001 *Ergonomics of the thermal environment. Medical supervision of individuals exposed to extreme hot or cold environments* British Standards Institution

BS EN 13698-1:2003 *Pallet production specification. Construction specification for 800 mm x 1200 mm flat wooden panels* British Standards Institution

BS EN 13698-2:2003 *Pallet production specification. Construction specification for 1000 mm x 1200 mm flat wooden panels* British Standards Institution

BS EN ISO 14122-3:2001 *Safety of machinery. Permanent means of access to machinery. Stairways, stepladders and guard-rails* British Standards Institution

BS EN ISO 14122-4:2004 *Safety of machinery. Permanent means of access to machinery. Fixed ladders* British Standards Institution

BS EN 60204-32:1998 *Safety of machinery. Electrical equipment of machines. Requirements for hoisting machines* British Standards Institution

BS EN 60529:1992 *Specification for degrees of protection provided by enclosures (IP code)* British Standards Institution

BS EN 60947-5-1:2004 *Specification for low-voltage switchgear and controlgear. Control circuit devices and switching elements. Electromechanical control circuit devices* British Standards Institution

BS EN 61000-6-2:2001 *Electromagnetic compatibility (EMC). Generic standards. Immunity for industrial environments* British Standards Institution

BS EN 61496:2004 *Safety of machinery. Electro-sensitive protective equipment. General requirements and tests* British Standards Institution

BS IEC 61496-2:1997 *Safety of machinery. Electro-sensitive protective equipment. Particular requirements for equipment using active opto-electronic protective devices (AOPDs)* British Standards Institution

BS IEC 61496-3:2001 *Safety of machinery. Electro-sensitive protective equipment. Particular requirements for active opto-electronic protective devices responsive to diffuse reflection (AOPDDR)* British Standards Institution

Further information

For information about health and safety ring HSE's Infoline Tel: 0845 345 0055
Fax: 0845 408 9566 Textphone: 0845 408 9577 e-mail: hse.infoline@natbrit.com or
write to HSE Information Services, Caerphilly Business Park, Caerphilly CF83 3GG.

HSE priced and free publications can be viewed online or ordered from
www.hse.gov.uk or contact HSE Books, PO Box 1999, Sudbury, Suffolk
CO10 2WA Tel: 01787 881165 Fax: 01787 313995. HSE priced publications
are also available from bookshops.

British Standards can be obtained in PDF or hard copy formats from the BSI online
shop: www.bsigroup.com/Shop or by contacting BSI Customer Services for hard
copies only Tel: 020 8996 9001 e-mail: cservices@bsigroup.com.

The Stationery Office publications are available from The Stationery Office,
PO Box 29, Norwich NR3 1GN Tel: 0870 600 5522 Fax: 0870 600 5533
e-mail: customer.services@tso.co.uk Website: www.tso.co.uk (They are also
available from bookshops.) Statutory Instruments can be viewed free of charge
at www.opsi.gov.uk.